

## 150mA, 40V Linear Regulator

### General Description

FC6295 is a linear regulator features wide input range, high power-supply rejection ratio(PSRR) and low noise. The device provides fixed output voltages of 3.3V and 5V. The output voltage is also adjustable. It can be programmed by a resistor divider from 1.5V to 24V.

The device also includes short circuit protection, over voltage protection and thermal shutdown. The shutdown current of FC6295 is as low as 2uA. Therefore, FC6295 is an ideal power supply for power delivery, personal digital assistants, low power battery-powered applications.

FC6295 is available in SOT23 -5 and SOT89-3



### Features

- Wide Input Voltage Range: From 6V to 40V
- Programmable Output Voltage: From 1.5V to 24V
- Up to 150mA Output Current
- Very Accurate Output Voltage: 3% Over Temperature and Input Voltage
- Accurate EN threshold for setting external UVLO
- High PSRR, 60dB
- Integrated Thermal and Current Limit

### Applications

- Space-Sensitive Applications
- Battery-Powered Equipment
- Cordless and Mobile Phones
- Industrial and Medical Equipment
- Portable Equipment



## 150mA, 40V Linear Regulator

### Order information

Product model	Package	Manner of packing	Minimum packing quantity
FC6295S3V33	SOT89-3	reel	1000
FC6295S3V50	SOT89-3		1000
FC6295S5ADJ	SOT23-5		3000
FC6295S5V33	SOT23-5		3000
FC6295S5V50	SOT23-5		3000

### Functional Block Diagram

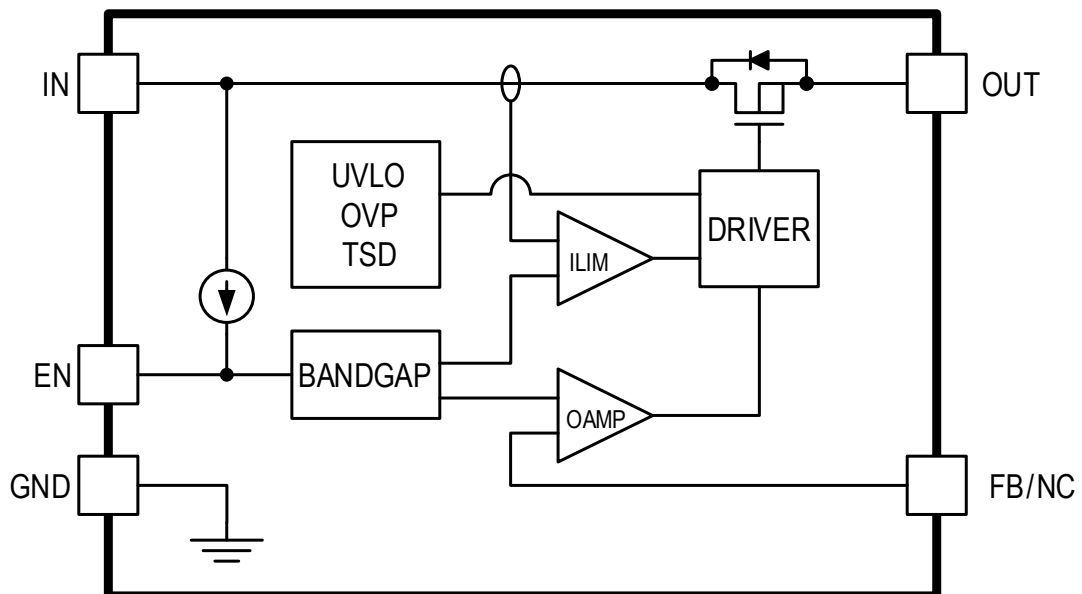

## 150mA, 40V Linear Regulator

### Pin Assignment

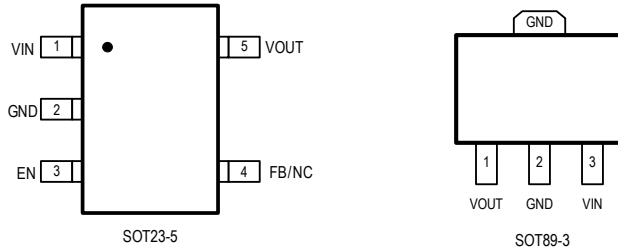

SOT23-5 PIN #	SOT89-3 PIN#	PIN NAME	DESCRIPTION
1	1	IN	Input Supply Pin
2	2	GND	Ground Pin
3	NA	EN	Enable Pin. Drive it high to enable IC, drive it low to disable
4	NA	FB/NC	Feedback pin for output voltage configuration, FB only for adjustable voltage version, fixed voltage version internal no connection
5	3	OUT	Output of regulator



## 150mA, 40V Linear Regulator

### Absolute Maximum Ratings

(Note: Exceeding these limits may damage the device. Exposure to absolute maximum rating conditions for long periods may affect device reliability.)

VIN to GND Voltage .....	-0.3V to 42V
VOU to GND Voltage.....	-0.3V to 42V
EN to GND Voltage .....	-0.3V to 42V
FB to GND Voltage.....	-0.3V to 6V
VOU current .....	Internally limited
Operating Temperature Range .....	-40°C to 85°C
Storage Temperature Range .....	-55°C to 150°C
Thermal Resistance	$\theta_{JC}$ $\theta_{JA}$
SOT23-5L.....	90.....180.....°C/W
SOT89-3.....	9.....52.....°C/W
Lead Temperature (Soldering,10sec).....	260°C
ESD HBM (Human Body Mode) .....	2KV
ESD MM (Machine Mode) .....	200V

### Electrical Characteristics

(VIN = VOUT(TYP)+≥1V, unless otherwise specified. Typical values are at TA = 25°C.)

SYMBOL	PARAMETER	TEST CONDITIONS	MIN	TYP	MAX	UNIT
VIN_RANGE	Input Supply Range		6		40	V
UVLO	Under Voltage Lock Output	VIN Rising		6		V
	UVLO Hysteresis	VIN Falling		500		mV
OVP	IN Over Voltage Protection Threshold	VIN Rising		40.5	44	V
	OVP Hysteresis	VIN Falling		1		V
IQ	Quiescent Current	EN = Floating		75	200	µA
ISD	Shutdown Current	EN = 0V		2	5	µA
VDROP	Dropout Voltage	VOUT = 12, IOUT = 100mA		1	1.5	V
VOUT_RANGE	Output Voltage Range		1.5		24	V
VOUT_ACC	Output Voltage Accuracy	TJ=25°C	-2		+2	%
		-40°C<TJ<125°C	-3		+3	%
VFB	FB Pin Regulation Voltage	TJ=25°C	1.083	1.1	1.117	V
		-40°C<TJ<125°C	1.075	1.1	1.125	V
ILIM	Output Current Limit		150			mA
IFB	Foldback Current Limit	VOUT = 0V		20		mA
VLOAD	Static Load Regulation	1mA<IOUT<150mA		0.003		%/mA
VLINE	Static Line Regulation	VOUT + 2V < VIN < 40V		0.05		%/V



## 150mA, 40V Linear Regulator

SYMBOL	PARAMETER	TEST CONDITIONS	MIN	TYP	MAX	UNIT
Noise	Output Noise Voltage	$V_{OUT} = 3.3V$ , integrated noise (10hz – 20khz)		250		$\mu V_{RMS}$
PSRR	Power Supply Rejection Ratio	Frequency = 1kHz, no output cap		60		dB
		Frequency = 10kHz, no output cap		50		dB
$T_{SHUT}$	Thermal Shutdown Threshold			150		°C
	Thermal Shutdown Threshold Hysteresis			30		
$T_{EN}$	Enable Delay Time			300		$\mu s$
$V_{HI}$	Enable Input Logic High	EN Pin Voltage Rising	1.1	1.18	1.26	V
$V_{LO}$	Enable Input Logic Low	EN Pin Voltage Falling		1		V
$I_{EN}$	Enable Pin Input Current	$V_{EN} = 24V$			2	$\mu A$

## 150mA, 40V Linear Regulator

### Application Circuits

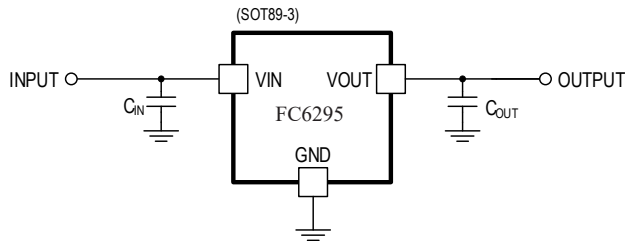
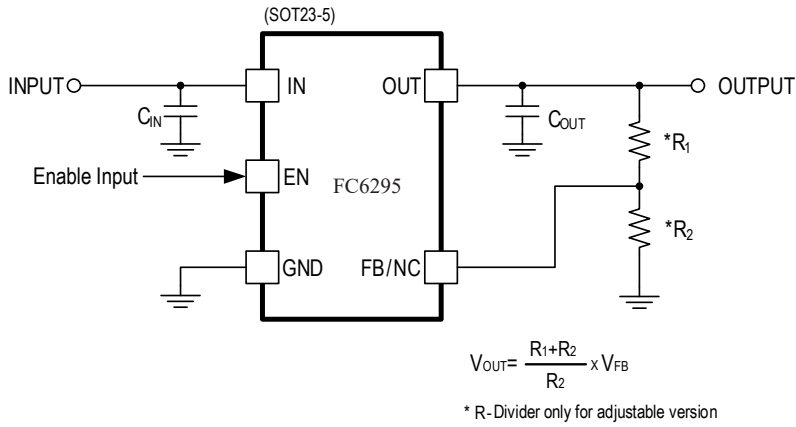



## 150mA, 40V Linear Regulator

### Typical Performance Characteristics

( $T_A=25^{\circ}\text{C}$ ,  $V_{IN} = 12\text{V}$  if not specified)

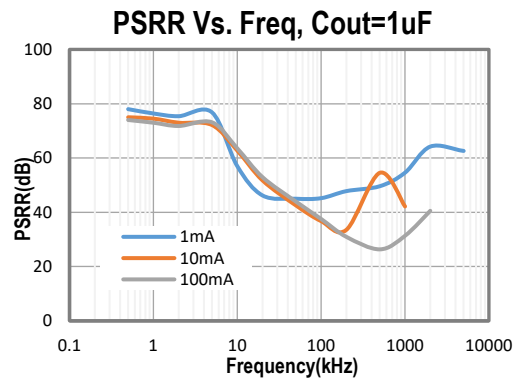
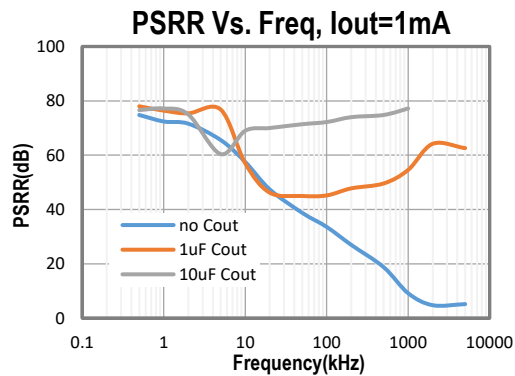
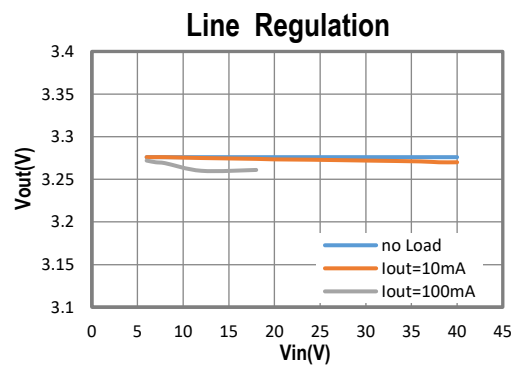
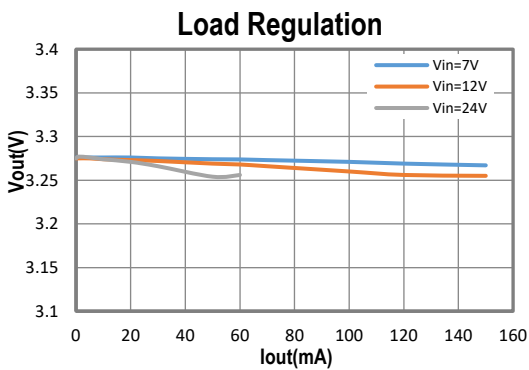
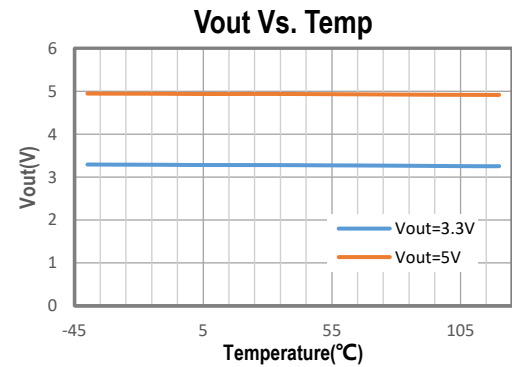
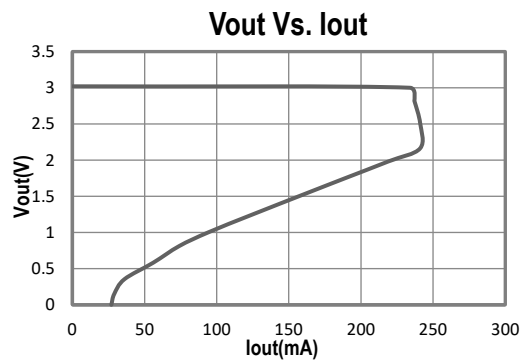
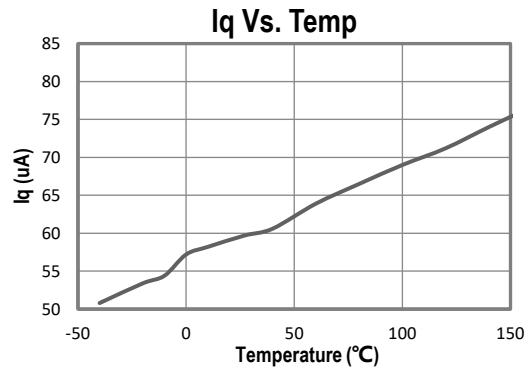
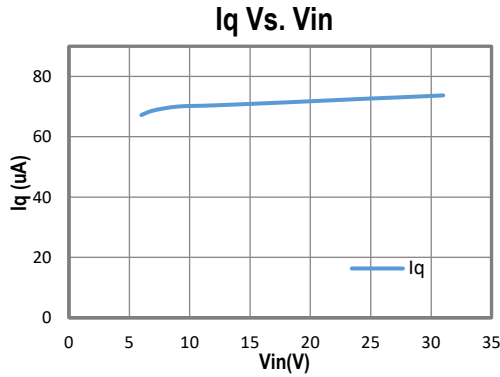



# 150mA, 40V Linear Regulator

## Typical Performance Characteristics Cont'd

(TA=25°C, V<sub>IN</sub> = 12V if not specified)

Output Load Transient without any Capacitor,  
V<sub>IN</sub> = 12V, V<sub>OUT</sub> = 3.3V

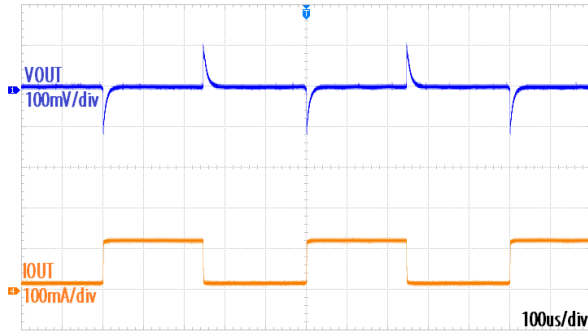

Output Load Transient with C<sub>OUT</sub> = 100nF,  
V<sub>IN</sub> = 12V, V<sub>OUT</sub> = 3.3V

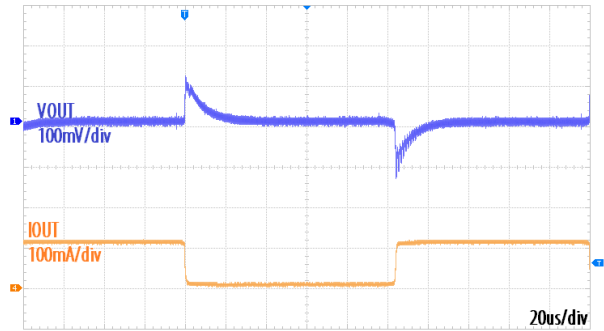

Output Load Transient without any Capacitor,  
V<sub>IN</sub> = 24V, V<sub>OUT</sub> = 12V

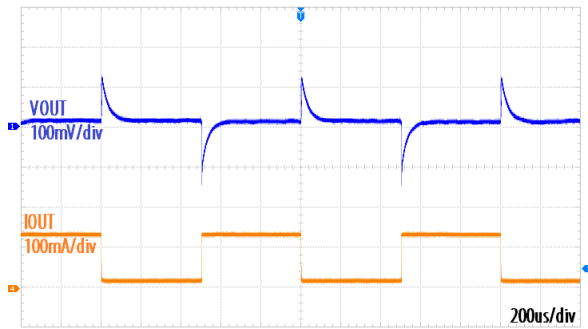

Output Load Transient with C<sub>OUT</sub> = 100nF,  
V<sub>IN</sub> = 24V, V<sub>OUT</sub> = 12V

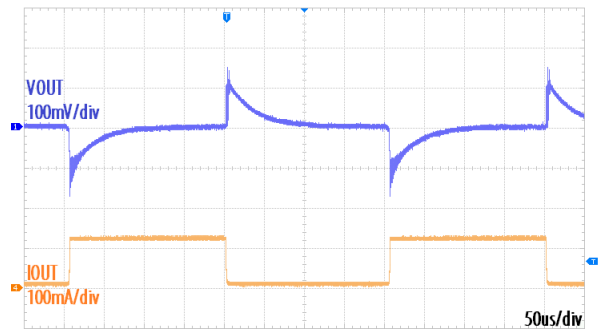

Line Transient Without Output Capacitor,  
V<sub>OUT</sub> = 3.3V, I<sub>OUT</sub> = 10mA

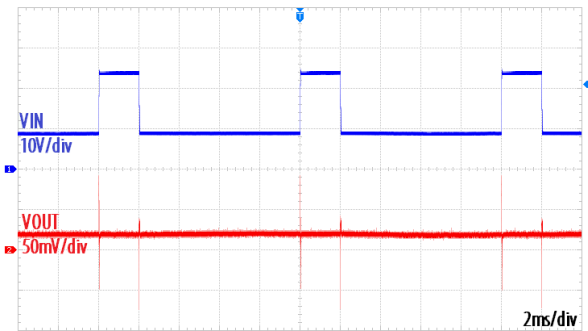

Line Transient Without Output Capacitor,  
V<sub>OUT</sub> = 12V, I<sub>OUT</sub> = 12mA

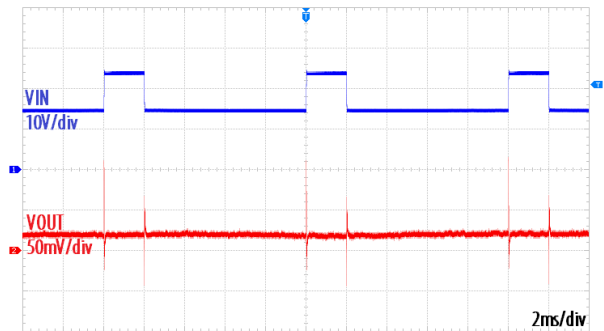





## 150mA, 40V Linear Regulator

### Functional Descripton

#### General Description

The main feature of the FC6295 is its capability to operate with wide input range and with small input and output capacitors. FC6295 use a new architecture of LDO to have sufficient phase margin over all positions of the output capacitor pole. It also includes protection features like input over voltage protection, short circuit protection and thermal shutdown.

#### Enable Sequence

FC6295 is enabled when all following conditions occur:

- ◆ EN pin voltage is greater than a logic high,
- ◆  $UVLO < V_{IN} < OVP$ ,
- ◆ Junction temperature is less than Thermal Shutdown,

Once all above conditions are occurred, FC6295 will be enabled after 500us. In case any of above conditions is not correct, FC6295 will be in shutdown mode. EN pin is internally pulled up to a Logic High.

#### Output Current Limit and Foldback Current Limit

The FC6295 guarantees 150mA output current for all output voltage configuration, so it is designed with 250mA (typically). FC6295 current limit is reduced when output voltage is less than 75% of the configuration. The reduction is linearity and finish when output voltage is at 25% when the limit is only 20mA (typically) left. This feature will make sure FC6295 will always do its start-up successfully with any load less than maximum loading.

#### Over-Temperature Protection

Thermal protection disables the output when the junction temperature rises to approximately 150°C, allowing the device to cool down. When the junction temperature cools to approximately 120°C, the output circuitry is again enabled. Depending on power dissipation, thermal resistance, and ambient temperature, the thermal protection circuit may cycle on and off. This cycling limits regulator dissipation, protecting the device from damage as a result of overheating.

### Application Information

#### Capacitor Selection

The FC6295 does not require high capacitors at both VIN and VOUT pins for stability. Using 100nF capacitor at VOUT will be suitable for the output voltage up to 8V, with any load type. Using 220nF capacitor at VOUT will be suitable for the output voltage up to 14V, with any load type.



## 150mA, 40V Linear Regulator

### External Output Voltage Setting

In external Output Voltage Setting Version selected, the FC6295 regulator is programmed using an external resistor divider. The output voltage is calculated using below equation.

$$V_{OUT} = V_{FB} \times \left(1 + \frac{R_1}{R_2}\right)$$

Resistors R1 and R2 should be chosen for approximately 40μA divider current. Lower value resistors can be used for improved noise performance, but the solution consumes more power. Higher resistors values can cause accuracy issues. The recommended design procedure is to choose R2 = 20kΩ to set the divider current at 40μA, then R1 is calculated using below equation.

$$R_1 = \left(\frac{V_{OUT}}{V_{FB}} - 1\right) \times R_2$$

## 150mA, 40V Linear Regulator

### Package Information

### 3-pin SOT89 Outline Dimensions

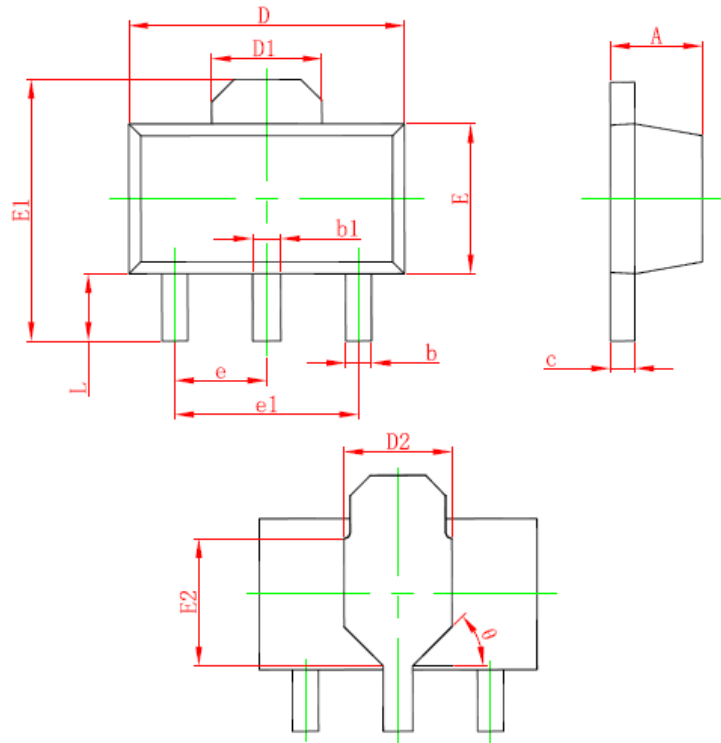

Symbol	Dimensions In Millimeters		Dimensions In Inches	
	Min.	Max.	Min.	Max.
A	1.400	1.600	0.055	0.063
b	0.320	0.520	0.013	0.020
b1	0.400	0.580	0.016	0.023
c	0.350	0.440	0.014	0.017
D	4.400	4.600	0.173	0.181
D1	1.550 REF.		0.061 REF.	
D2	1.750 REF.		0.069 REF.	
E	2.300	2.600	0.091	0.102
E1	3.940	4.250	0.155	0.167
E2	1.900 REF.		0.075 REF.	
e	1.500 TYP.		0.060 TYP.	
e1	3.000 TYP.		0.118 TYP.	
L	0.900	1.200	0.035	0.047
θ	45°		45°	



150mA, 40V Linear Regulator

SOT23-5 Outline Dimensions

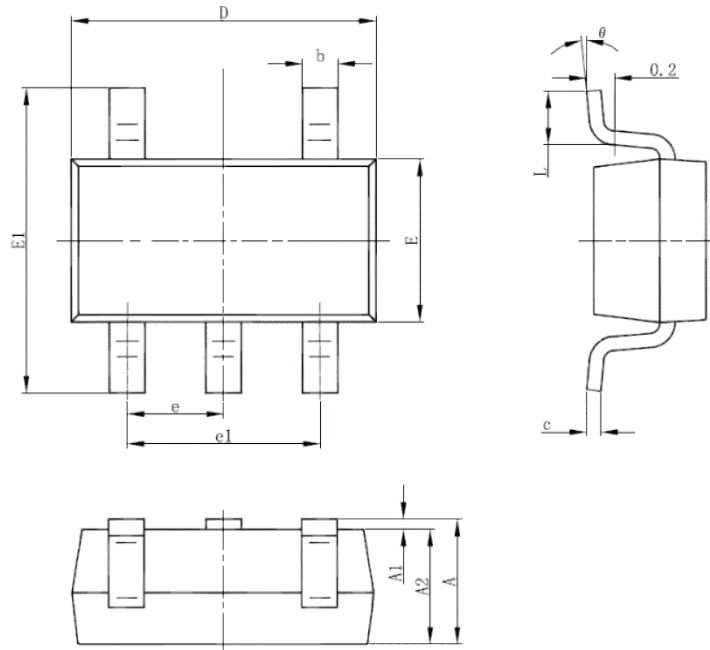

Symbol	Dimensions In Millimeters		Dimensions In Inches	
	Min	Max	Min	Max
A	1.050	1.250	0.041	0.049
A1	0.000	0.100	0.000	0.004
A2	1.050	1.150	0.041	0.045
b	0.300	0.500	0.012	0.020
c	0.100	0.200	0.004	0.008
D	2.820	3.020	0.111	0.119
E	1.500	1.700	0.059	0.067
E1	2.650	2.950	0.104	0.116
e	0.950(BSC)		0.037(BSC)	
e1	1.800	2.000	0.071	0.079
L	0.300	0.600	0.012	0.024
θ	0°	8°	0°	8°