

General Purpose Transistor

PNP Silicon

These transistors are designed for general purpose amplifier applications. They are housed in the SOT-323/SC-70 which is designed for low power surface mount applications.

Features

We declare that the material of product compliance with RoHS requirements.

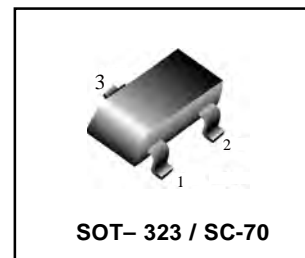

MAXIMUM RATINGS

Rating	Symbol	BC856U	BC857U	BC858U	Unit
Collector-Emitter Voltage	V_{CEO}	-65	-45	-30	V
Collector-Base Voltage	V_{CBO}	-80	-50	-30	V
Emitter-Base Voltage	V_{EBO}	-5.0	-5.0	-5.0	V
Collector Current — Continuous	I_C	-100	-100	-100	mAdc

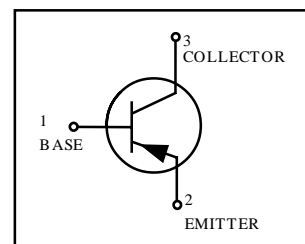

THERMAL CHARACTERISTICS

Characteristic	Symbol	Max	Unit
Total Device Dissipation FR-5 Board, (1) $T_A = 25^\circ\text{C}$	P_D	150	mW
Thermal Resistance, Junction to Ambient	$R_{\theta JA}$	833	$^\circ\text{C/W}$
Junction and Storage Temperature	T_J, T_{stg}	-55 to +150	$^\circ\text{C}$

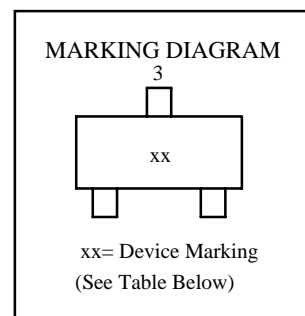

DEVICE MARKING

BC856UA=3A, BC856UB=3B, BC857UA=3E, BC857UB=3F
BC858UA=3J, BC858UB=3K, BC858UC=3L

ELECTRICAL CHARACTERISTICS ($T_A = 25^\circ\text{C}$ unless otherwise noted.)

Characteristic	Symbol	Min	Typ	Max	Unit
----------------	--------	-----	-----	-----	------

OFF CHARACTERISTICS

Collector-Emitter Breakdown Voltage ($I_C = -10\text{ mA}$)	BC856U Series BC857U Series BC858U Series	$V_{(BR)CEO}$	-65 -45 -30	— — —	— — —	v
Collector-Emitter Breakdown Voltage ($I_C = -10\ \mu\text{A}, V_{EB} = 0$)	BC856U Series BC857U Series BC858U Series	$V_{(BR)CES}$	-80 -50 -30	— — —	— — —	v
Collector-Base Breakdown Voltage ($I_C = -10\ \mu\text{A}$)	BC856U Series BC857U Series BC858U Series	$V_{(BR)CBO}$	-80 -50 -30	— — —	— — —	v
Emitter-Base Breakdown Voltage ($I_E = -1.0\ \mu\text{A}$)	BC856U Series BC857U Series BC858U Series	$V_{(BR)EBO}$	-5.0 -5.0 -5.0	— — —	— — —	v
Collector Cutoff Current ($V_{CB} = -30\text{ V}$) ($V_{CB} = -30\text{ V}, T_A = 150^\circ\text{C}$)		I_{CBO}	— —	— —	-15 -4.0	nA μA

1.FR-5=1.0 x 0.75 x 0.062in



ELECTRICAL CHARACTERISTICS ($T_A = 25^\circ\text{C}$ unless otherwise noted) (Continued)

Characteristic	Symbol	Min	Typ	Max	Unit
----------------	--------	-----	-----	-----	------

ON CHARACTERISTICS

DC Current Gain ($I_C = -10 \mu\text{A}$, $V_{CE} = -5.0 \text{ V}$)	BC856UA, BC857UA, BC858UA	h_{FE}	—	90	—	—
	BC856UB, BC857UB, BC858UB		—	150	—	
	BC858UC,		—	270	—	
($I_C = -2.0 \text{ mA}$, $V_{CE} = -5.0 \text{ V}$)	BC856UA, BC857UA, BC858UA		125	180	250	
	BC856UB, BC857UB, BC858UB		220	290	475	
	BC858UC,		420	520	800	
Collector–Emitter Saturation Voltage ($I_C = -10 \text{ mA}$, $I_B = -0.5 \text{ mA}$) ($I_C = -100 \text{ mA}$, $I_B = -5.0 \text{ mA}$)		$V_{CE(sat)}$	—	—	-0.3	V
			—	—	-0.65	
Base–Emitter Saturation Voltage ($I_C = -10 \text{ mA}$, $I_B = -0.5 \text{ mA}$) ($I_C = -100 \text{ mA}$, $I_B = -5.0 \text{ mA}$)		$V_{BE(sat)}$	—	-0.7	—	V
			—	-0.9	—	
Base–Emitter Voltage ($I_C = -2.0 \text{ mA}$, $V_{CE} = -5.0 \text{ V}$) ($I_C = -10 \text{ mA}$, $V_{CE} = -5.0 \text{ V}$)		$V_{BE(on)}$	-0.6	—	-0.75	V
			—	—	-0.82	

SMALL–SIGNAL CHARACTERISTICS

Current–Gain — Bandwidth Product ($I_C = -10 \text{ mA}$, $V_{CE} = -5.0 \text{ Vdc}$, $f = 100 \text{ MHz}$)	f_T	100	—	—	MHz
Output Capacitance ($V_{CB} = -10 \text{ V}$, $f = 1.0 \text{ MHz}$)	C_{ob}	—	—	4.5	pF
Noise Figure ($I_C = -0.2 \text{ mA}$, $V_{CE} = -5.0 \text{ Vdc}$, $R_S = 2.0 \text{ k}\Omega$, $f = 1.0 \text{ kHz}$, $BW = 200 \text{ Hz}$)	NF	—	—	10	dB

BC857U / BC858U

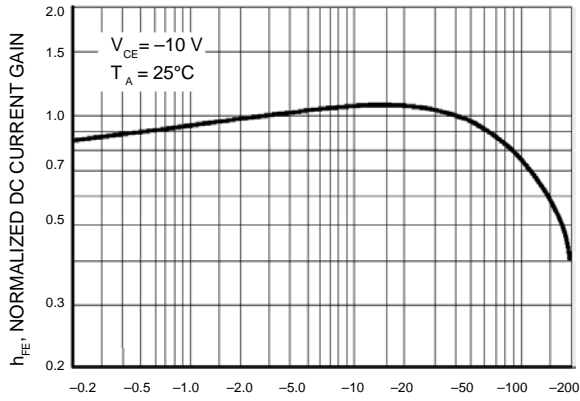

I_C , COLLECTOR CURRENT (mAdc)
Figure 1. Normalized DC Current Gain

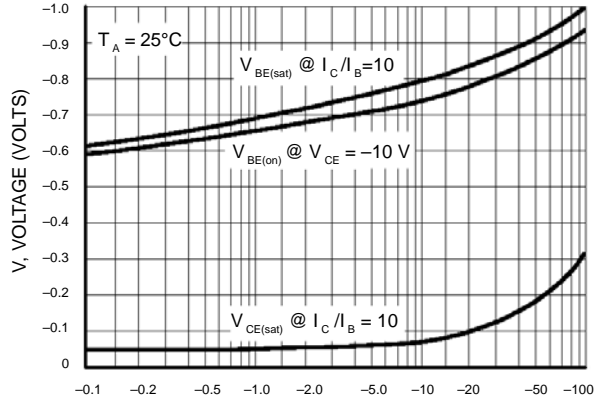

I_C , COLLECTOR CURRENT (mAdc)
Figure 2. "Saturation" and "On" Voltages

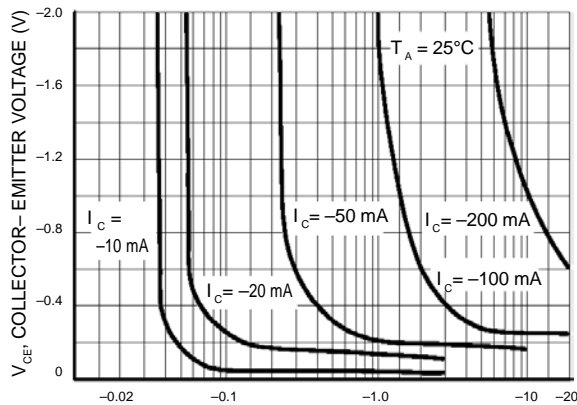

I_B , BASE CURRENT (mA)
Figure 3. Collector Saturation Region

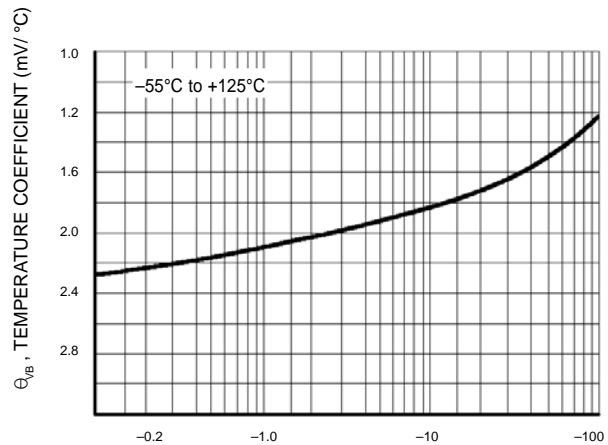

I_C , COLLECTOR CURRENT (mA)
Figure 4. Base-Emitter Temperature Coefficient

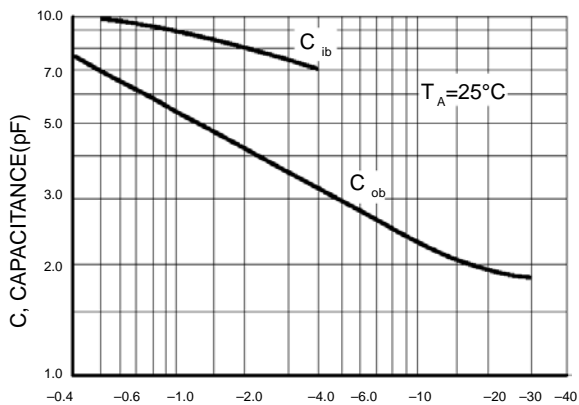

V_R , REVERSE VOLTAGE (VOLTS)
Figure 5. Capacitances

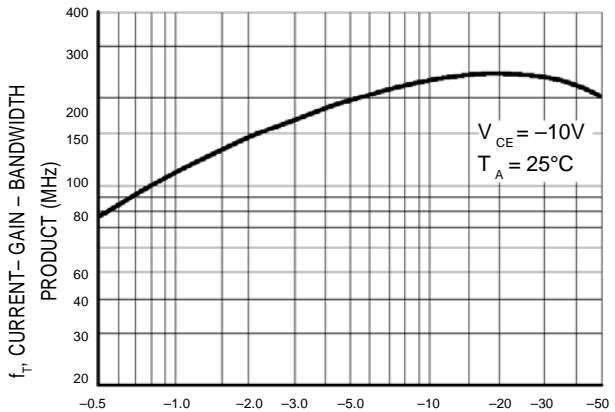

I_C , COLLECTOR CURRENT (mAdc)
Figure 6. Current-Gain - Bandwidth Product

BC856U

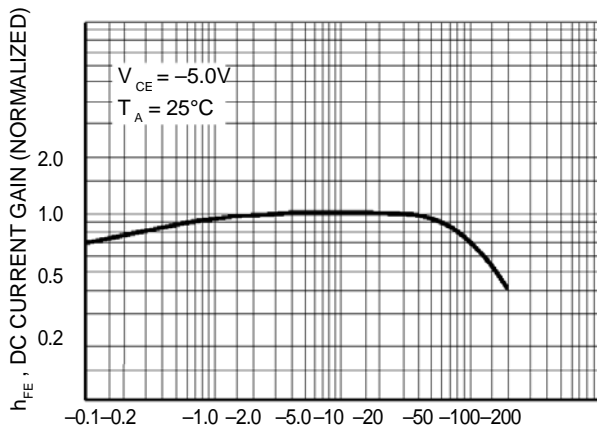

Figure 7. DC Current Gain

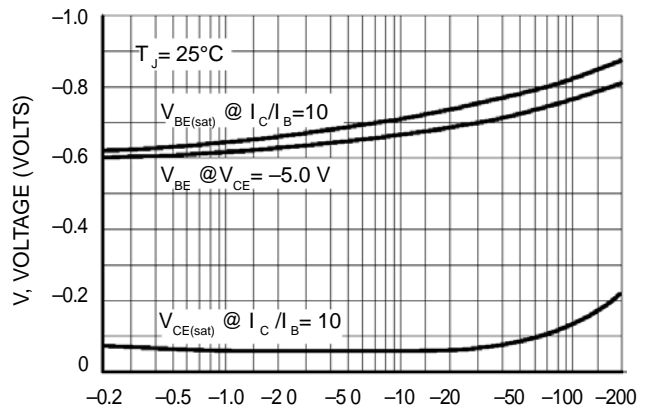

Figure 8. "On" Voltage

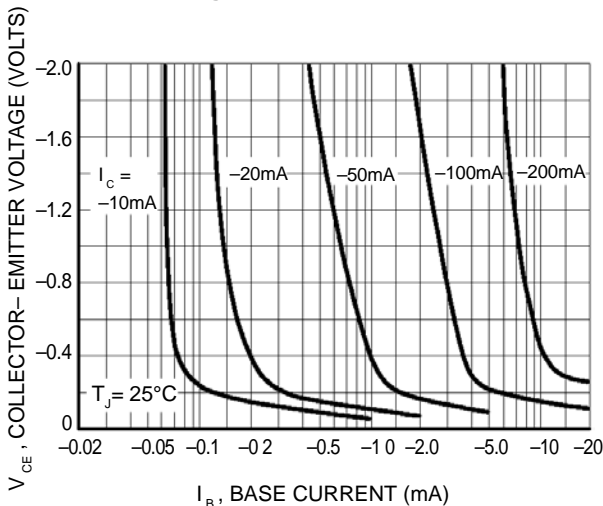

Figure 9. Collector Saturation Region

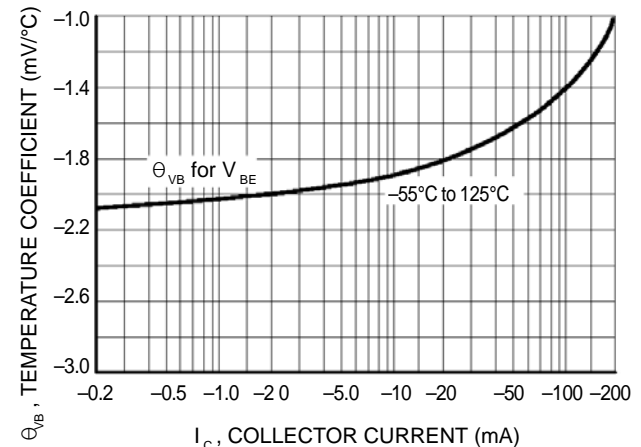

Figure 10. Base-Emitter Temperature Coefficient

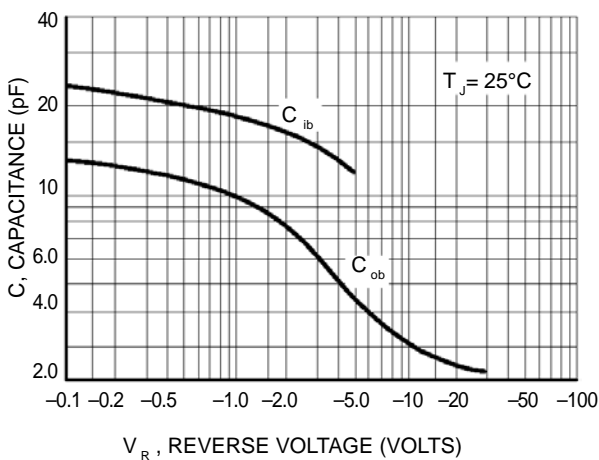

Figure 11. Capacitance

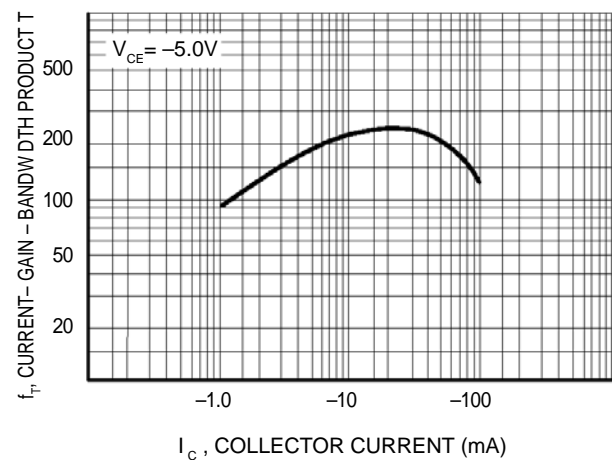

Figure 12. Current-Gain - Bandwidth Product

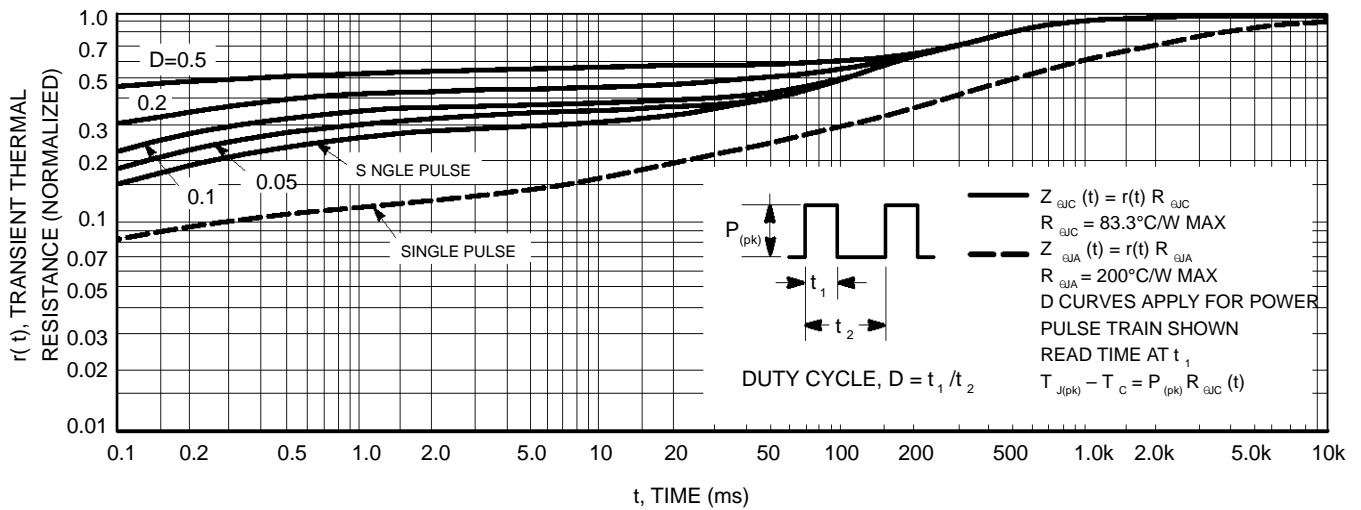

Figure 13. Thermal Response

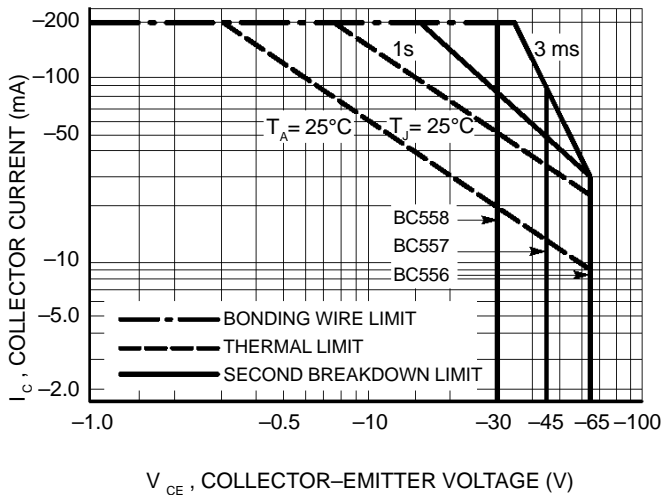

Figure 14. Active Region Safe Operating Area

The safe operating area curves indicate $I_C - V_{CE}$ limits of the transistor that must be observed for reliable operation. Collector load lines for specific circuits must fall below the limits indicated by the applicable curve.

The data of Figure 14 is based upon $T_{J(pk)} = 150^\circ\text{C}$; T_C or T_A is variable depending upon conditions. Pulse curves are valid for duty cycles to 10% provided $T_{J(pk)} \leq 150^\circ\text{C}$. $T_{J(pk)}$ may be calculated from the data in Figure 13. At high case or ambient temperatures, thermal limitations will reduce the power that can be handled to values less than the limitations imposed by the secondary breakdown.

SC-70 / SOT-323

NOTES

1. DIMENSIONING AND TOLERANCING PER ANSI Y14.5M, 1982.
2. CONTROLLING DIMENSION: INCH.

DIM	INCHES		MILLIMETERS	
	MIN	MAX	MIN	MAX
A	0.071	0.087	1.80	2.20
B	0.045	0.053	1.15	1.35
C	0.032	0.040	0.80	1.00
D	0.012	0.016	0.30	0.40
G	0.047	0.055	1.20	1.40
H	0.000	0.004	0.00	0.10
J	0.004	0.010	0.10	0.25
K	0.017 REF		0.425 REF	
L	0.026 BSC		0.650 BSC	
N	0.028 REF		0.700 REF	
S	0.079	0.095	2.00	2.40

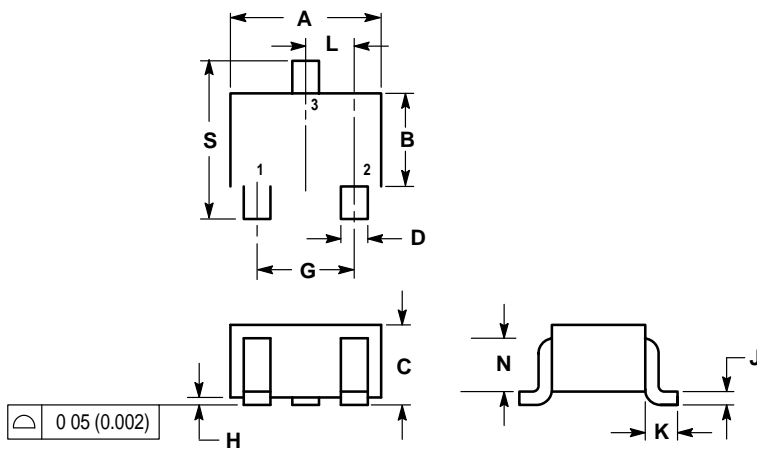

- PIN 1. BASE
 2. EMITTER
 3. COLLECTOR

