

TO-92 Plastic-Encapsulate Transistors

MPS751 TRANSISTOR (PNP)

FEATURES

Switching and Amplifier Applications

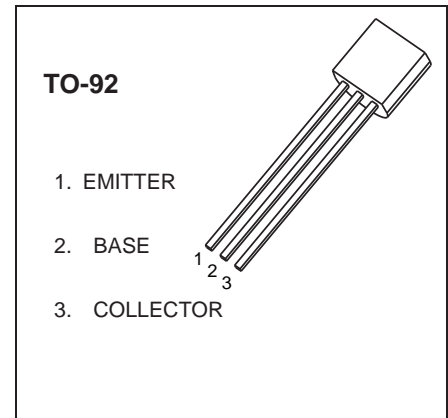

MARKING

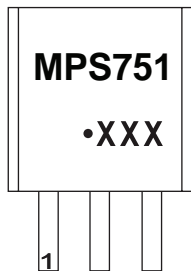

MPS751=Device code
Solid dot= Green molding compound device,
if none, the normal device
XXX=Code

Equivalent Circuit

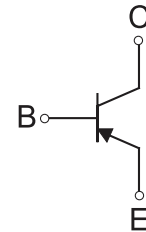

ORDERING INFORMATION

Part Number	Package	Packing Method	Pack Quantity
MPS751	TO-92	Tape	2000pcs/Box

MAXIMUM RATINGS (T_a=25°C unless otherwise noted)

Symbol	Parameter	Value	Unit
V _{CB0}	Collector-Base Voltage	-80	V
V _{CE0}	Collector-Emitter Voltage	-60	V
V _{EB0}	Emitter-Base Voltage	-5	V
I _c	Collector Current -Continuous	-2	A
P _c	Collector Dissipation	0.625	W
R _{θJA}	Thermal Resistance from Junction to Ambient	200	°C/W
T _J	Junction Temperature	150	°C
T _{stg}	Storage Temperature	-55-150	°C



MPS751

ELECTRICAL CHARACTERISTICS (T_a=25°C unless otherwise specified)

Parameter	Symbol	Test conditions	Min	Typ	Max	Unit
Collector-base breakdown voltage	V _{(BR)CBO}	I _C =-100μA, I _E =0	-80			V
Collector-emitter breakdown voltage	V _{(BR)CEO} *	I _C =-10mA, I _B =0	-60			V
Emitter-base breakdown voltage	V _{(BR)EBO}	I _E =-10μA, I _C =0	-5			V
Collector cut-off current	I _{CBO}	V _{CB} =-80V, I _E =0			-0.1	μA
Emitter cut-off current	I _{EBO}	V _{EB} =-4V, I _C =0			-0.1	μA
DC current gain	h _{FE(1)} *	V _{CE} =-2V, I _C =-50mA	75			
	h _{FE(2)} *	V _{CE} =-2V, I _C =-500mA	75			
	h _{FE(3)} *	V _{CE} =-2V, I _C =-1A	75			
	h _{FE(4)} *	V _{CE} =-2V, I _C =-2A	40			
Collector-emitter saturation voltage	V _{CE(sat)} *	I _C =-2A, I _B =-200mA			-0.5	V
		I _C =-1A, I _B =-100mA			-0.3	
Base -emitter saturation voltage	V _{BE(sat)} *	I _C =-1A, I _B =-100mA			-1.2	V
Base -emitter on voltage	V _{BE(on)} *	V _{CE} =-2V, I _C =-1A			-1	V
Transition frequency	f _T	V _{CE} =-5V, I _C =-50mA, f=100MHz	75			MHz

* Pulse Test: Pulse Width<= 300us, Duty Cycle = 2.0%.

Typical Characteristics

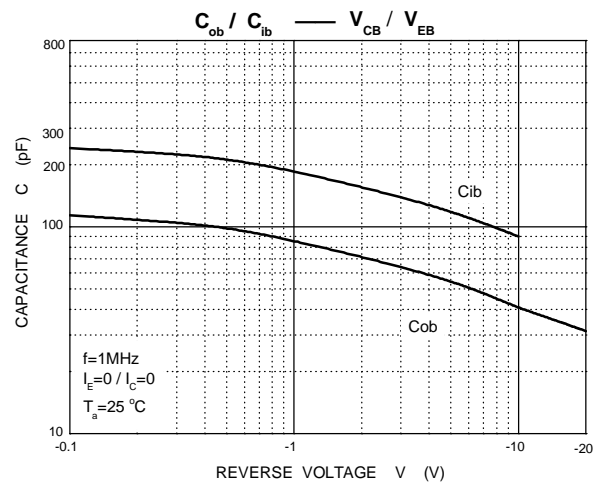
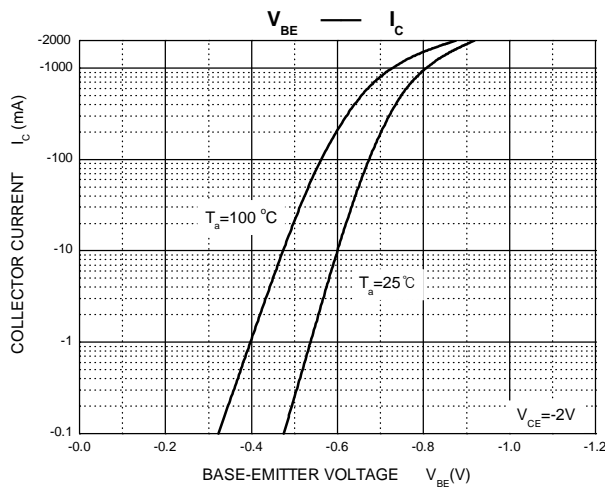
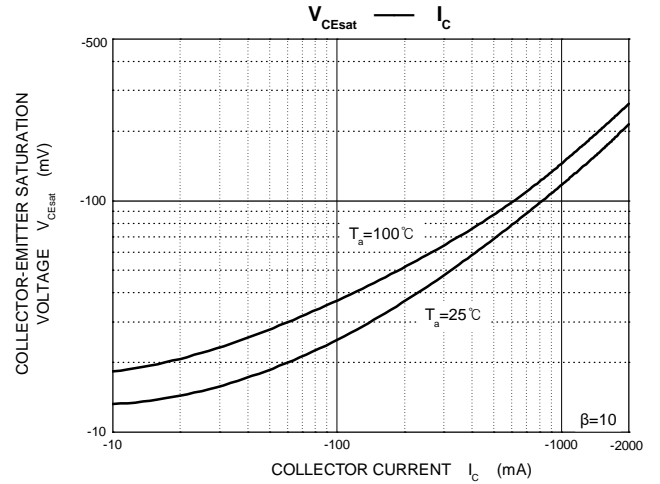
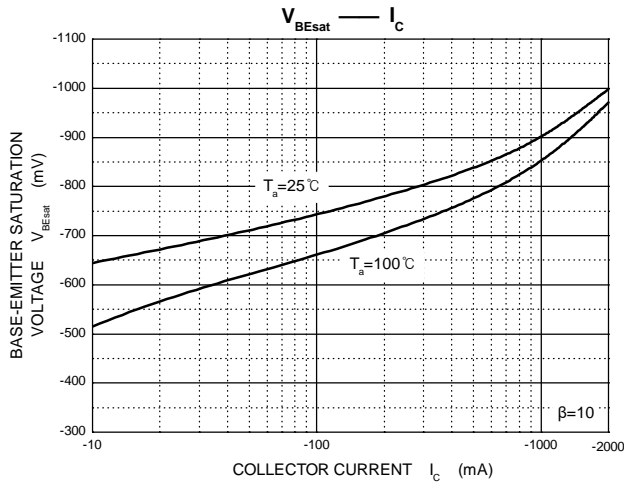
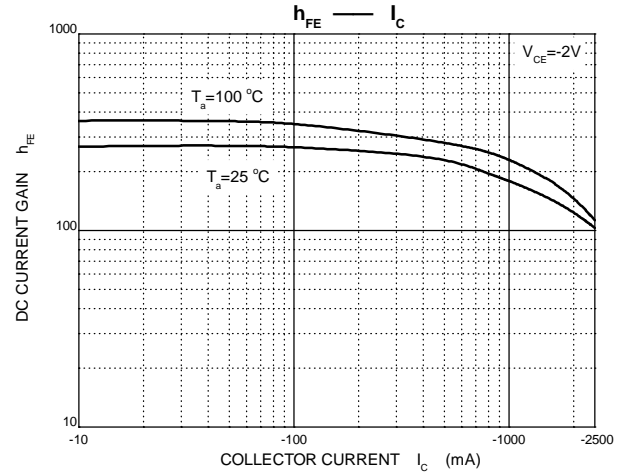
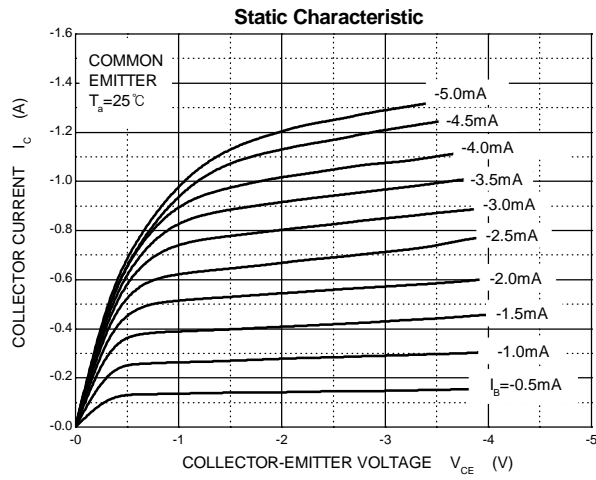



MPS751

Typical Characteristics(Con.)

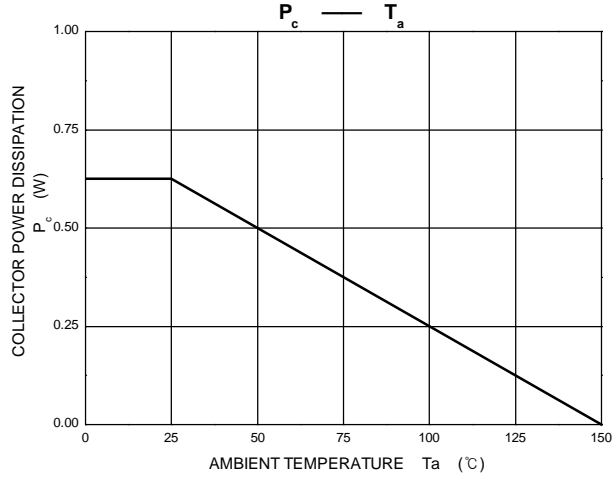

TO-92 Package Outline Dimensions

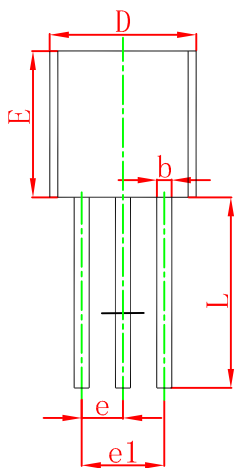
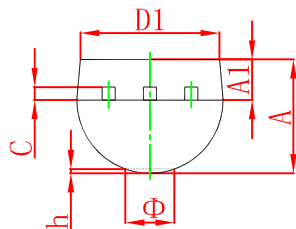

Symbol	Dimensions In Millimeters		Dimensions In Inches	
	Min	Max	Min	Max
A	3.300	3.700	0.130	0.146
A1	1.100	1.400	0.043	0.055
b	0.380	0.550	0.015	0.022
c	0.360	0.510	0.014	0.020
D	4.300	4.700	0.169	0.185
D1	3.430		0.135	
E	4.300	4.700	0.169	0.185
e	1.270 TYP		0.050 TYP	
e1	2.440	2.640	0.096	0.104
L	14.100	14.500	0.555	0.571
Φ		1.600		0.063
h	0.000	0.380	0.000	0.015

TO-92 Suggested Pad Layout

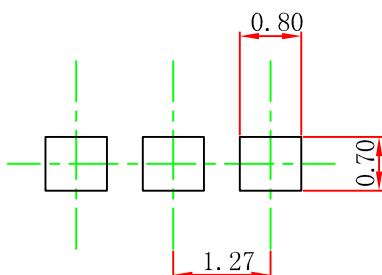

Note:

1. Controlling dimension: in millimeters.
2. General tolerance: $\pm 0.05\text{mm}$.
3. The pad layout is for reference purposes only.

TO-92 Tape and Reel

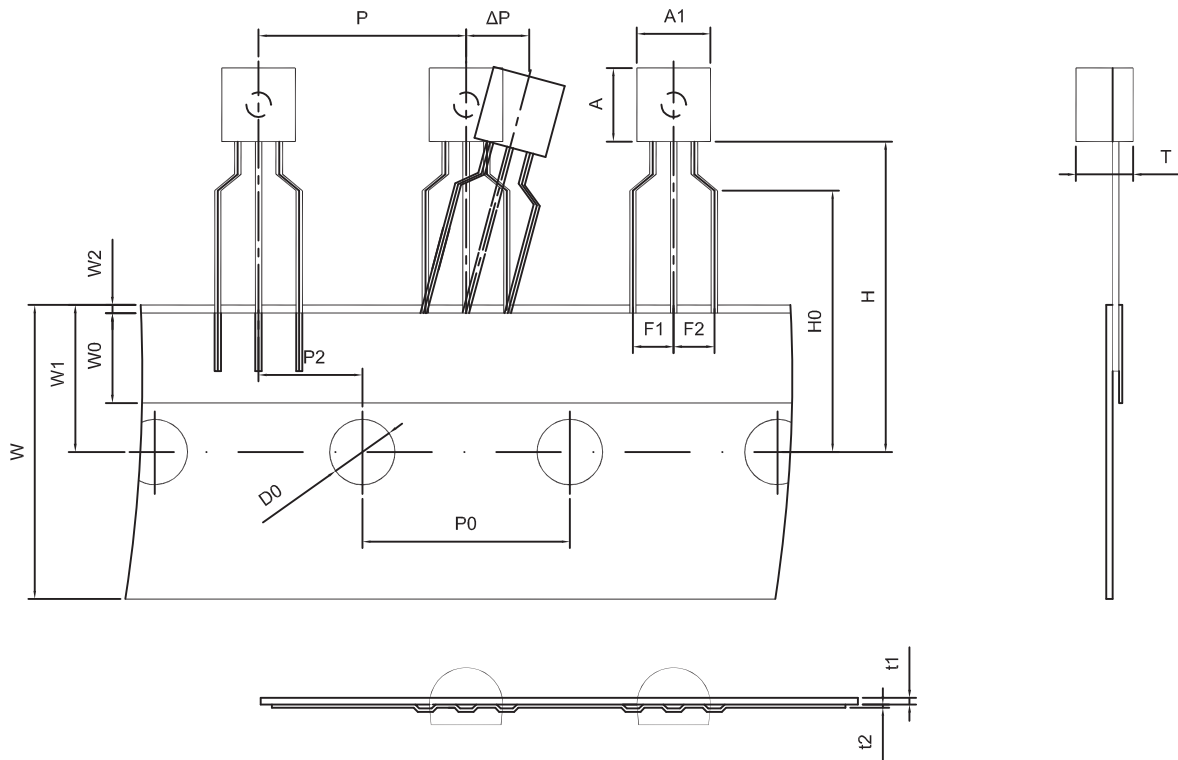

Dimensions are in millimeter

A1	A	T	P	P0	P2	F1	F2	W
4.5	4.5	3.5	12.7	12.7	6.35	2.5	2.5	18.0
W0	W1	W2	H	H0	D0	t1	t2	ΔP
6.0	9.0	1.0 MAX.	19.0	16.0	4.0	0.4	0.2	0

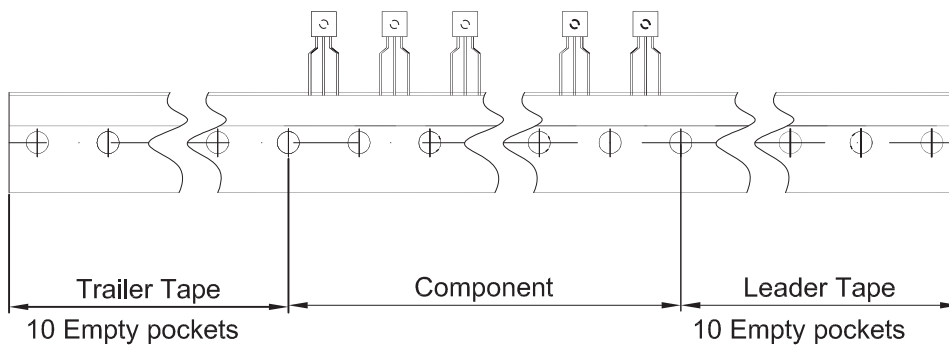

Package	Box	Box Size(mm)	Carton	Carton Size(mm)
TO-92	2000 pcs	333×162×43	20,000 pcs	350×340×250