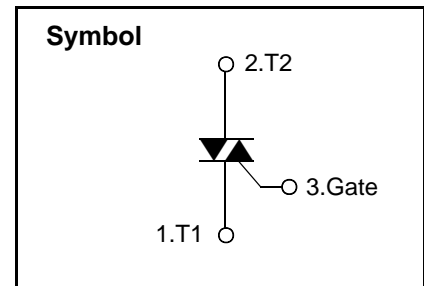
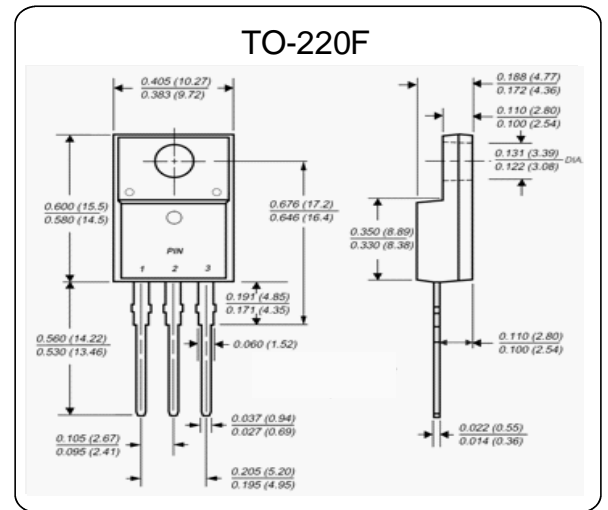


## Bi-Directional Triode Thyristor

Designed for high performance full-wave ac control applications where high noise immunity and high commutating di/dt are required.

### Features

- Blocking Voltage to 600 V
- On- State Current Rating of 8A RMS at 100 °C
- Uniform Gate Trigger Currents in Three Quadrants
- High Immunity to dV/dt- 1500V/us minimum at 125 °C
- Minimizes Snubber Networks for Protection
- Industry Standard TO- 220F Package
- High Commutating dI/dt- 4.0A/ms minimum at 125 °C
- Internally Isolated (2500VRMS)
- These are Pb- Free Devices



### Absolute Maximum Ratings

Symbol	Parameter		Value	Unit
$I_{T(RMS)}$	RMS on-state current(full sine wave)	TO-220F TC=100°C	8	A
$I_{TSM}$	Non repetitive surge peak on-state current(full cycle, T <sub>j</sub> initial=25°C)	F=50Hz t=20ms	80	A
		F=60Hz t=16.7ms	84	
$I^2t$	$I^2t$ Value for fusing	tp=10ms	36	A <sup>2</sup> s
DI/DT	Critical rate of rise of on-state current IG=2XIGT, tr≤100ns	F=120Hz Tj=125°C	50	A/us
$I_{GM}$	Peak gate current	tp=20us Tj=125°C	4	A
$P_{G(AV)}$	Average gate power dissipation	Tj=125°C	1	W
T <sub>stg</sub>	Storage junction temperature range		-40 to +150	°C
T <sub>j</sub>	Operating junction temperature range		-40 to +125	



# BT08F-600B

## Electrical Characteristics (Tj=25°C, unless otherwise specified)

### Snubberless™ and Logic Level(3 quadrants)

Symbol	Test conditions	Quadrant	BT08F-600B		Unit
I <sub>GT</sub> (1)	V <sub>D</sub> =12V R <sub>L</sub> =30Ω	I - II -III -IV	MAX	50	mA
V <sub>GT</sub>		I - II -III -IV	MAX	1.3	V
V <sub>GD</sub>	V <sub>D</sub> =V <sub>DRM</sub> R <sub>L</sub> =3.3KΩTj=125°C	I - II -III -IV	MIN	0.2	V
I <sub>H</sub> (2)	IT=100mA		MAX	50	mA
I <sub>L</sub>	I <sub>G</sub> =1.2I <sub>GT</sub>	I - II -III -IV	MAX	70	mA
		II		80	
Dv / Dt(2)	V <sub>D</sub> =67%V <sub>DRM</sub> Gate open Tj=125°C		MIN	1000	V/us
(DI/dt)c(2)	(Dv/dt)c=0.1 V/us Tj=125°C		MIN	-	A/ms
	(Dv/dt)c=10V/us Tj=125°C			-	
	Without snubber Tj=125°C			7	

### Standard (4Quadrants)

Symbol	Test conditions	Quadrant	BT08F-600B		Unit
I <sub>GT</sub> (1)	V <sub>D</sub> =12V R <sub>L</sub> =30Ω	I - II -III	MAX	50	mA
		IV		100	
V <sub>GT</sub>		ALL	MAX	1.3	V
V <sub>GD</sub>	V <sub>D</sub> =V <sub>DRM</sub> R <sub>L</sub> =3.3KΩTj=125°C	ALL	MIN	0.2	V
I <sub>H</sub> (2)	IT=500mA		MAX	50	mA
I <sub>L</sub>	I <sub>G</sub> =1.2I <sub>GT</sub>	I -III- IV	MAX	50	mA
		II		100	
(DI/dt)(2)	V <sub>D</sub> =67%V <sub>DRM</sub> Gate open Tj=125°C		MIN	400	V/us
(DI/dt)c(2)	(Dv/dt)c=3.5 A/ms Tj=125°C		MIN	10	V/us

### Static Characteristics

Symbol	Test conditions			Value	Unit
V <sub>TM</sub> (2)	ITM=11A tp=380us	T <sub>J</sub> =25°C	MAX	1.55	V
V <sub>to</sub> (2)	Threshold voltage	T <sub>J</sub> =125°C	MAX	0.85	V
R <sub>d</sub> (2)	Dynamic resistance	T <sub>J</sub> =125°C	MAX	50	mΩ
I <sub>DRM</sub>	V <sub>DRM</sub> =V <sub>R<sub>RRM</sub></sub>	T <sub>J</sub> =25°C		5	uA
I <sub>R<sub>RRM</sub></sub>		T <sub>J</sub> =125°C	MAX	1	mA
V <sub>DRM</sub> /V <sub>R<sub>RRM</sub></sub>	Voltage	T <sub>J</sub> =25°C	MIN	600	V

Note 1: minimum I<sub>GT</sub> is guaranteed at 5% of I<sub>GT</sub> max

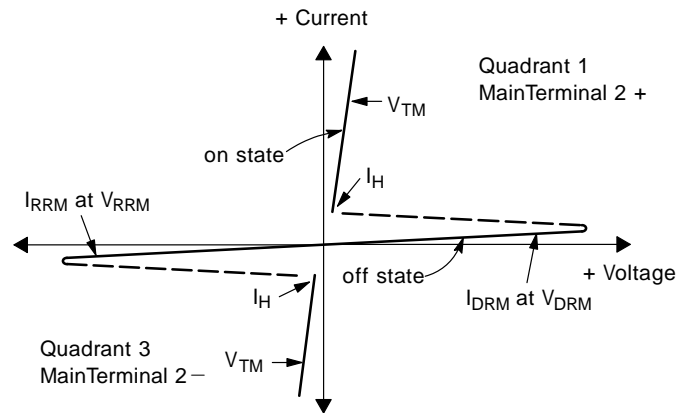
Note 2: for both polarities of A2 referenced to A1

### Thermal Resistances

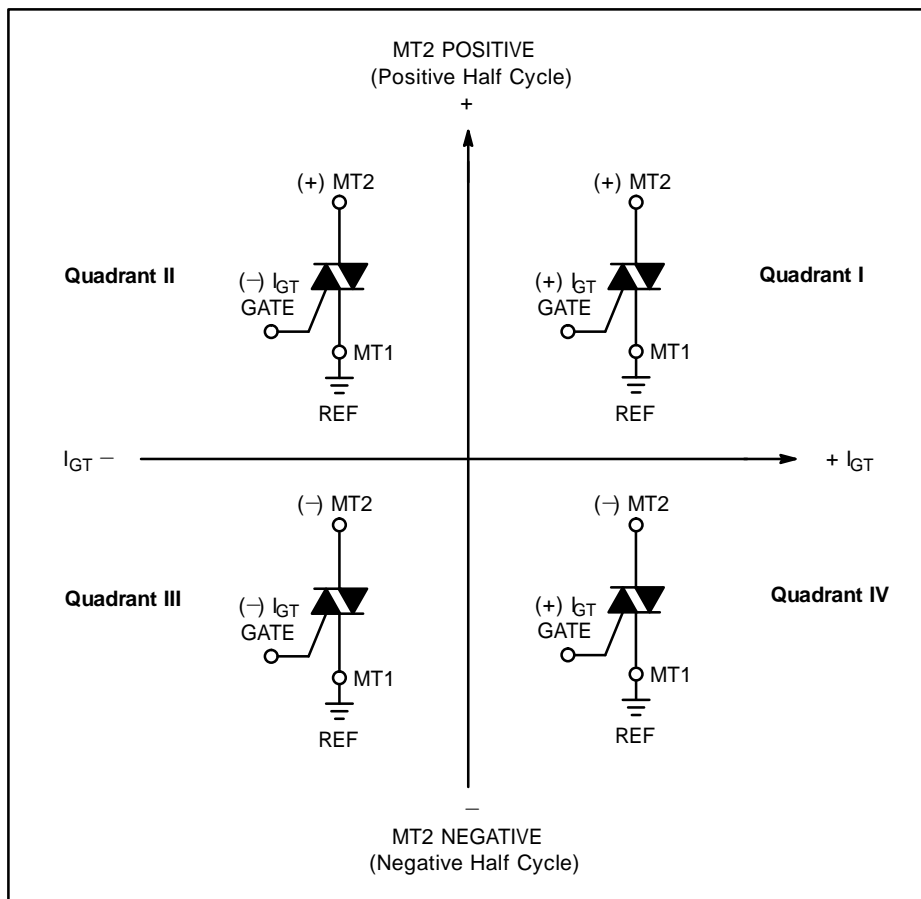
Symbol	Parameter		Value	Unit
R <sub>th(j-c)</sub>	Junction to case(AC)	TO-220F	2.5	°C/W
R <sub>th(j-a)</sub>	Junction to ambient	TO-220F	60	°C/W

## Voltage Current Characteristic of Triacs (Bidirectional Device)

Symbol	Parameter
$V_{DRM}$	Peak Repetitive Forward Off State Voltage
$I_{DRM}$	Peak Forward Blocking Current
$V_{RRM}$	Peak Repetitive Reverse Off State Voltage
$I_{RRM}$	Peak Reverse Blocking Current
$V_{TM}$	Maximum On State Voltage
$I_H$	Holding Current



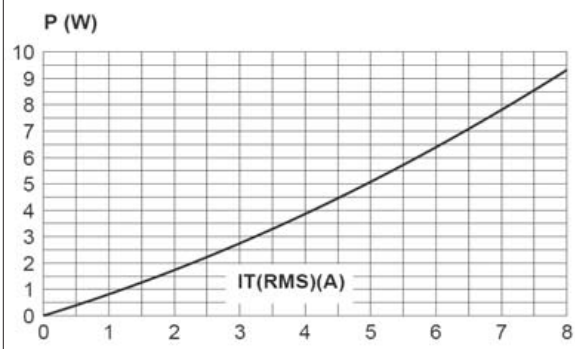
### Quadrant Definitions for a Triac



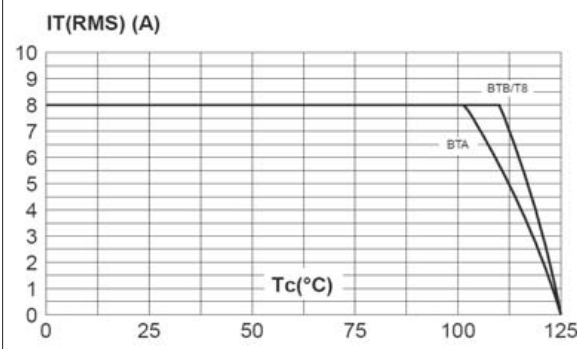
All polarities are referenced to MT1.  
 With in-phase signals (using standard AC lines) quadrants I and III are used.

## Description

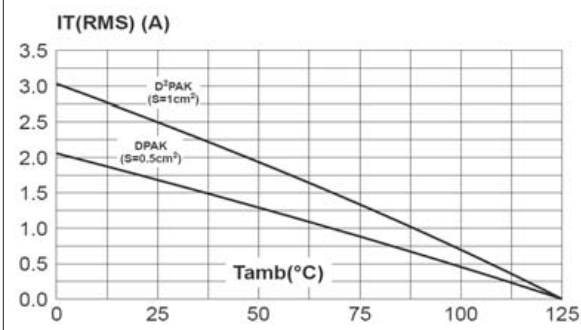
**Fig. 1:** Maximum power dissipation versus RMS on-state current (full cycle).



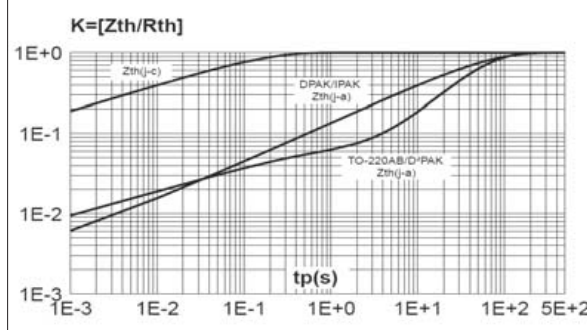
**Fig. 2-1:** RMS on-state current versus case temperature (full cycle).



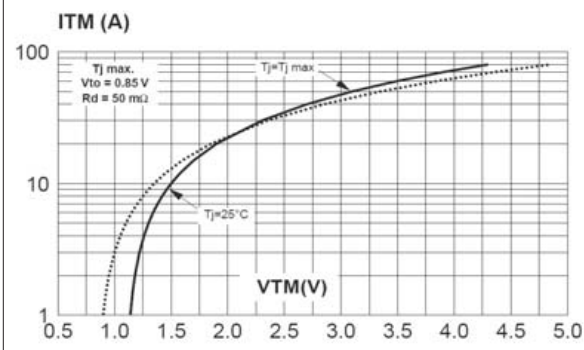
**Fig. 2-2:** RMS on-state current versus ambient temperature (printed circuit board FR4, copper thickness: 35µm), full cycle.



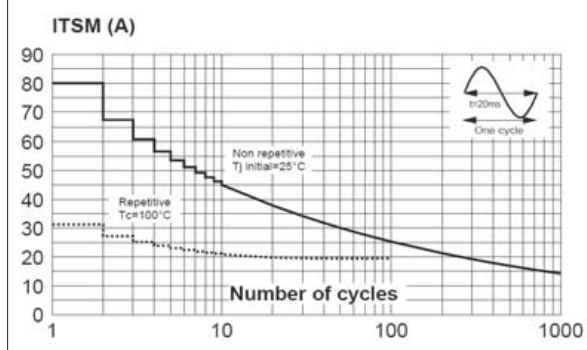
**Fig. 3:** Relative variation of thermal impedance versus pulse duration.



**Fig. 4:** On-state characteristics (maximum values).

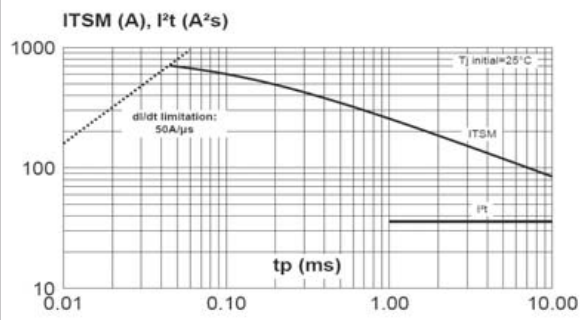


**Fig. 5:** Surge peak on-state current versus number of cycles.

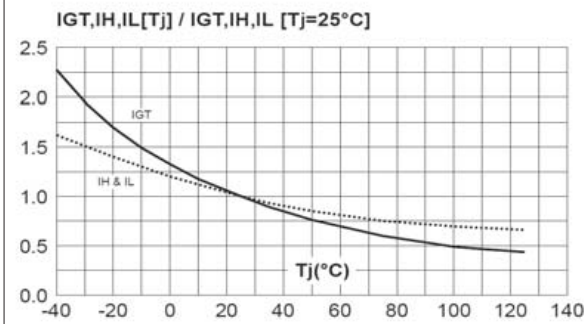


## Description

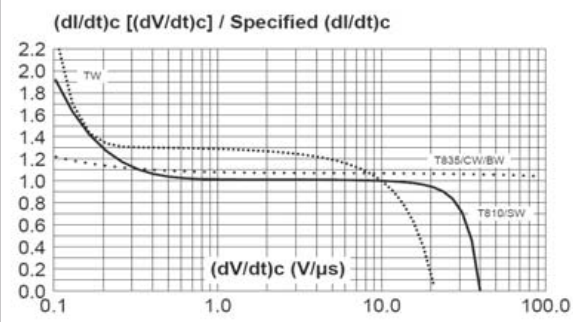
**Fig. 6:** Non-repetitive surge peak on-state current for a sinusoidal pulse with width  $t_p < 10\text{ms}$ , and corresponding value of  $I^2t$ .



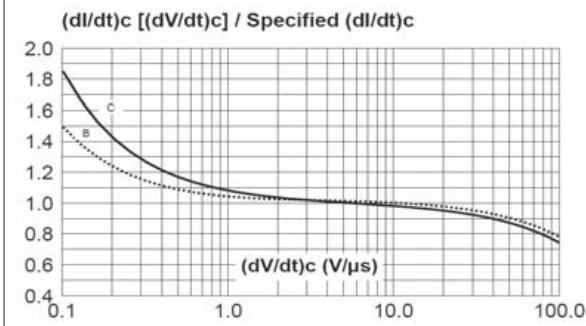
**Fig. 7:** Relative variation of gate trigger current, holding current and latching current versus junction temperature (typical values).



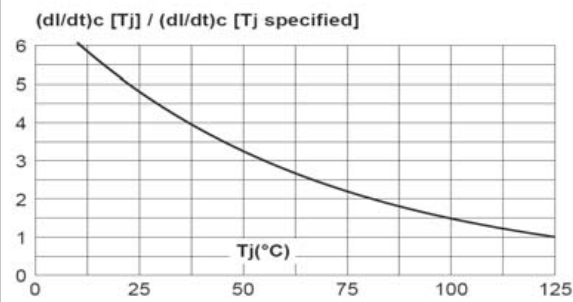
**Fig. 8-1:** Relative variation of critical rate of decrease of main current versus  $(dV/dt)_c$  (typical values). Snubberless & Logic Level Types



**Fig. 8-2:** Relative variation of critical rate of decrease of main current versus  $(dV/dt)_c$  (typical values). Standard Types



**Fig. 9:** Relative variation of critical rate of decrease of main current versus junction temperature.



**Fig. 10:** DPAK and D<sup>2</sup>PAK Thermal resistance junction to ambient versus copper surface under tab (printed circuit board FR4, copper thickness: 35 μm).

