

Bi-Directional Triode Thyristor

Designed for high performance full-wave ac control applications where high noise immunity and high commutating di/dt are required.

Features

- Blocking Voltage to 800 V
- On-State Current Rating of 16A RMS at 80°C
- Uniform Gate Trigger Currents in Three Quadrants
- High Immunity to dV/dt-1500V/us minimum at 125°C
- Minimizes Snubber Networks for Protection
- Industry Standard TO-220AB Package
- High Commutating dI/dt- 4.0A/ms minimum at 125°C
- Internally Isolated (2500VRMS)
- These are Pb-Free Devices

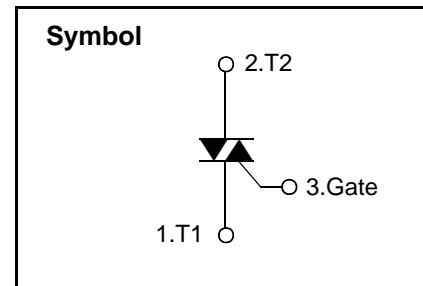
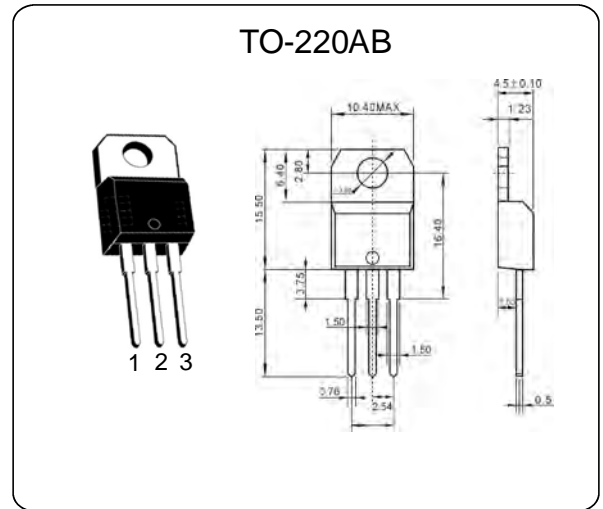

Absolute Maximum Ratings

Symbol	Parameter		Value	Unit	
I _{T(RMS)}	RMS on-state current(full sine wave)	TO-220AB TC=100°C	16	A	
		TO-220AB Ins. TC=85°C			
I _{TSM}	Non repetitive surge peak on-state current(full cycle, T _j initial=25°C)	F=50Hz t=20ms	160	A	
		F=60Hz t=16.7ms	168		
I ² t	I ² t Value for fusing	tp=10ms	144	A ² s	
DI/DT	Critical rate of rise of on-state current IG=2XIGT, tr≤100ns	F=120Hz Tj=125°C	50	A/us	
VDSM/V RSM	Non repetitive surge peak off-state voltage	tp=10ms Tj=25°C	Vdrm / vrrm + 100V	V	
IGM	Peak gate current	tp=20us Tj=125°C	4	A	
P _{G(AV)}	Average gate power dissipation		Tj=125°C	1	W
T _{stg}	Storage junction temperature range		-40 to +150	°C	
T _j	Operating junction temperature range		-40 to +125		

Electrical Characteristics (T_j=25 °C, unless otherwise specified)

Snubberless™ and Logic Level (3 quadrants)

Symbol	Test conditions	Quadrant	BTA16-800C		Unit
I _{GT} (1)	V _D =12V R _L =33Ω	I - II - III	MAX	35	mA
V _{GT}		I - II - III	MAX	1.3	V
V _{GD}	V _D =V _{DRM} R _L =3.3KΩ T _j =125 °C	I - II - III	MIN	0.2	V
I _H (2)	I _T =500mA		MAX	50	mA
I _L	I _G =1.2I _{GT}	I - III	MAX	70	mA
		II		80	
Dv / Dt(2)	V _D =67%V _{DRM} Gate open T _j =125 °C		MIN	1000	V/us
(DI/dt) _c (2)	(Dv/dt) _c =0.1V/us T _j =125 °C		MIN	-	A/ms
	(Dv/dt) _c =10V/us T _j =125 °C			-	
	Without snubber T _j =125 °C			14	

Standard (4 Quadrants)

Symbol	Test conditions	Quadrant	BTA16-800C		Unit
I _{GT} (1)	V _D =12V R _L =33Ω	I - II - III	MAX	35	mA
		IV		50	
V _{GT}		ALL	MAX	1.3	V
V _{GD}	V _D =V _{DRM} R _L =3.3KΩ T _j =125 °C	ALL	MIN	0.2	V
I _H (2)	I _T =500mA		MAX	50	mA
I _L	I _G =1.2I _{GT}	I - III - IV	MAX	60	mA
		II		120	
(DI/dt)(2)	V _D =67%V _{DRM} Gate open T _j =125 °C		MIN	400	V/us
(DI/dt) _c (2)	(Dv/dt) _c =7A/ms T _j =125 °C		MIN	10	V/us

Static Characteristics

Symbol	Test conditions			Value	Unit
V _{TM} (2)	I _{TM} =22A t _p =380us	T _J =25 °C	MAX	1.55	V
V _{to} (2)	Threshold voltage	T _J =125 °C	MAX	0.85	V
R _d (2)	Dynamic resistance	T _J =125 °C	MAX	25	mΩ
I _{DRM} I _R RRM	V _{DRM} =V _R RRM	T _J =25 °C	MAX	5	uA
		T _J =125 °C		2	mA
V _{DRM} /V _R RRM	Voltage	T _J =25 °C	MIN	800	V

Note 1: minimum I_{GT} is guaranteed at 5% of I_{GT} max

Note 2: for both polarities of A2 referenced to A1

Thermal Resistances

Symbol	Parameter		Value	Unit
R _{th(j-c)}	Junction to case(AC)	TO-220AB	1.2	°C/W
		TO-220AB(Insulated)	2.1	
R _{th(j-a)}	Junction to ambient	TO-220AB/ TO-220AB(Insulated)	60	°C/W

Voltage Current Characteristic of Triacs (Bidirectional Device)

Symbol	Parameter
V_{DRM}	Peak Repetitive Forward Off State Voltage
I_{DRM}	Peak Forward Blocking Current
V_{RRM}	Peak Repetitive Reverse Off State Voltage
I_{RRM}	Peak Reverse Blocking Current
V_{TM}	Maximum On State Voltage
I_H	Holding Current

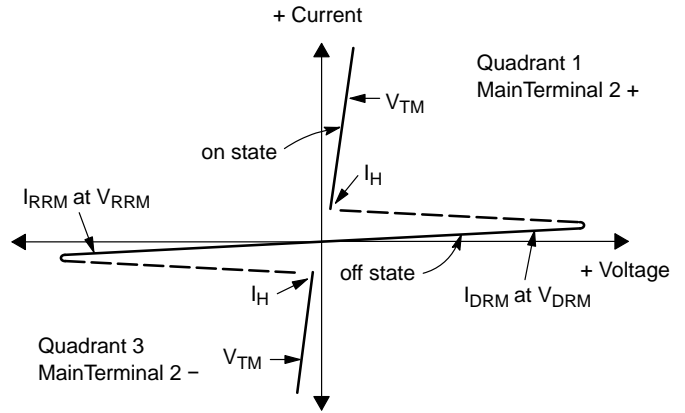

Quadrant Definitions for a Triac

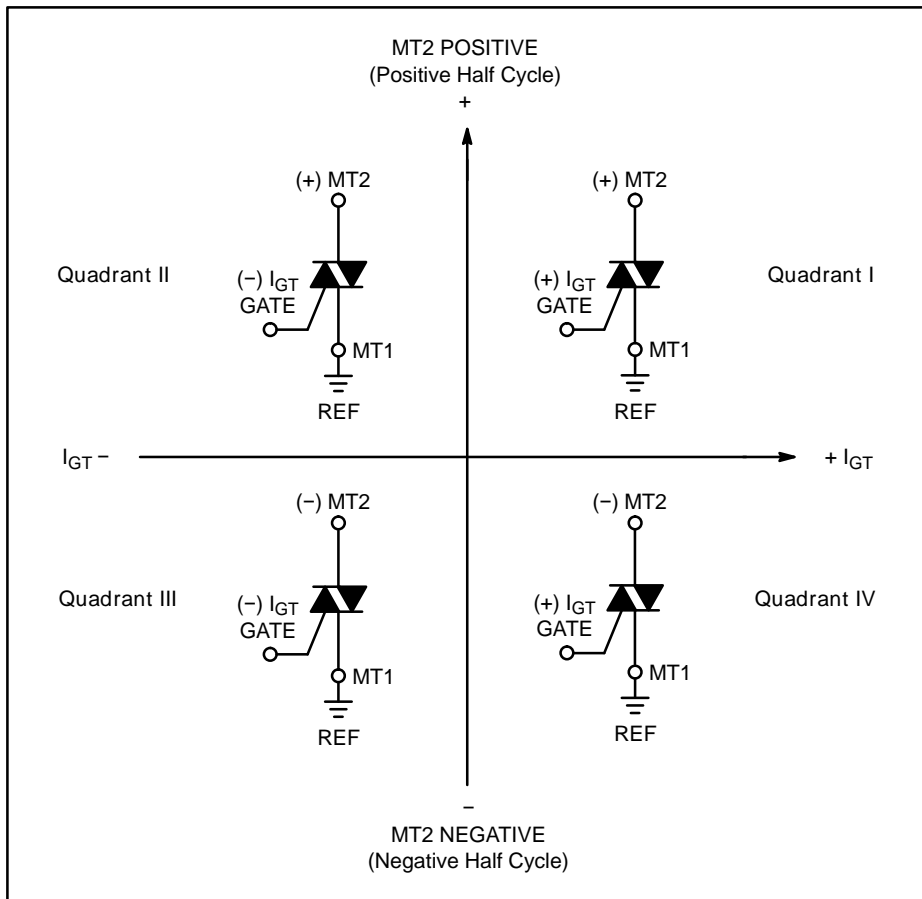

All polarities are referenced to MT1.
 With in-phase signals (using standard AC lines) quadrants I and III are used.

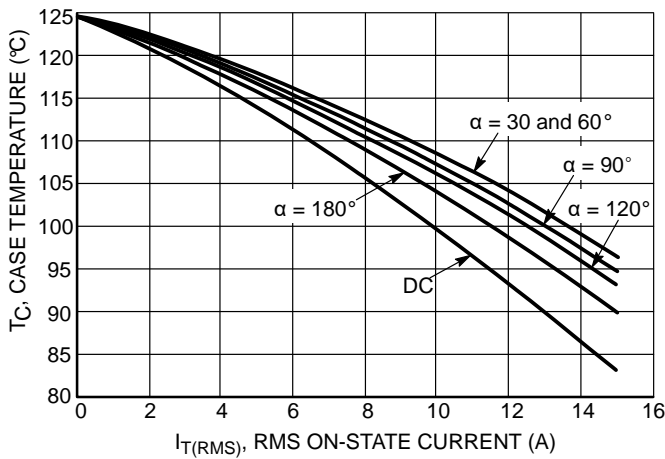

Figure 1. RMS Current Derating

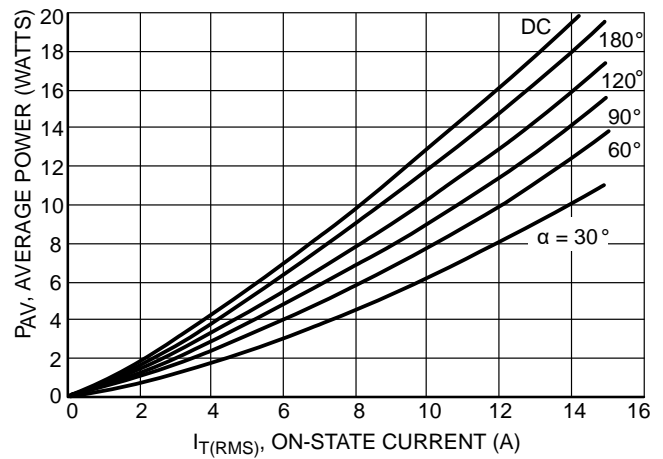

Figure 2. On-State Power Dissipation

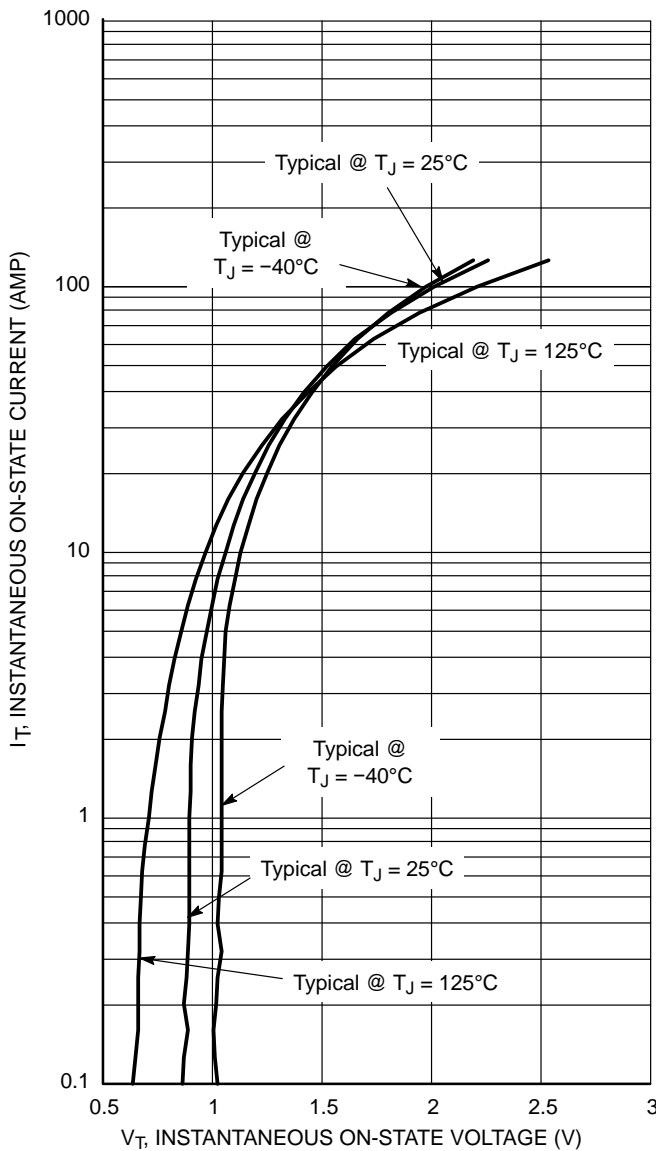

Figure 3. On-State Characteristics

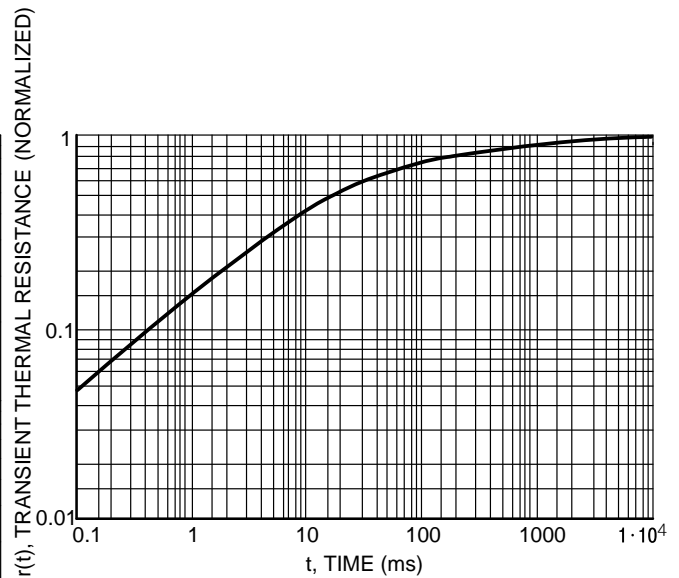

Figure 4. Thermal Response

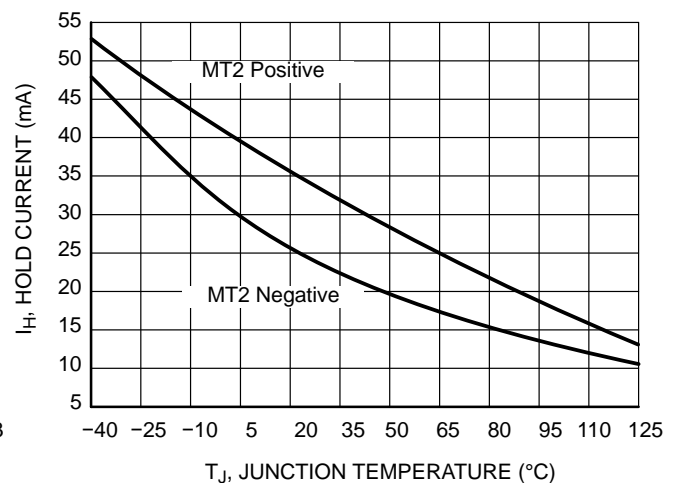

Figure 5. Hold Current Variation

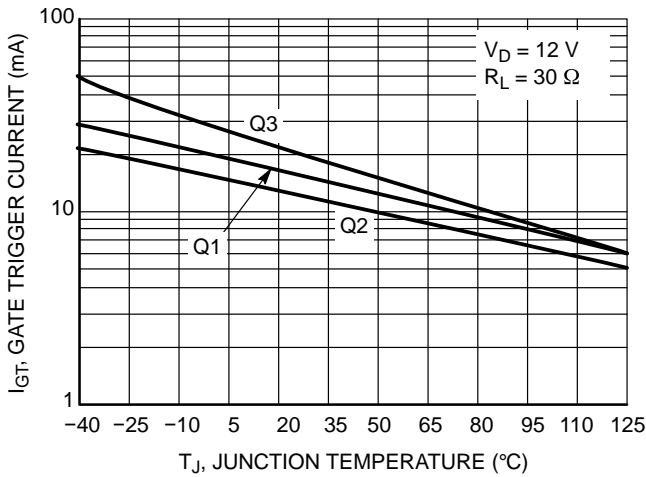

Figure 6. Gate Trigger Current Variation

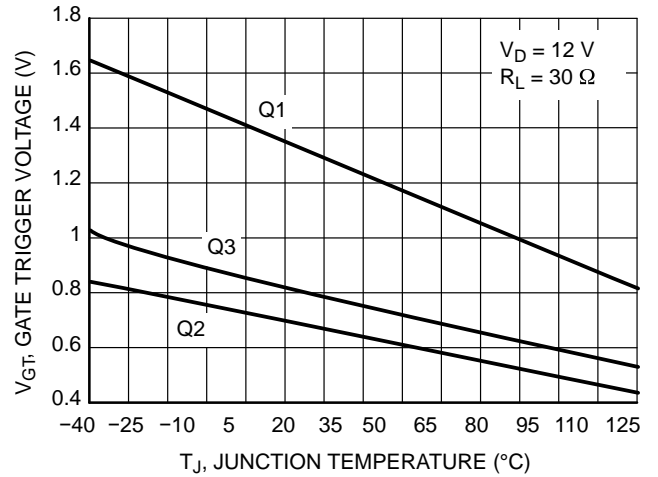

Figure 7. Gate Trigger Voltage Variation

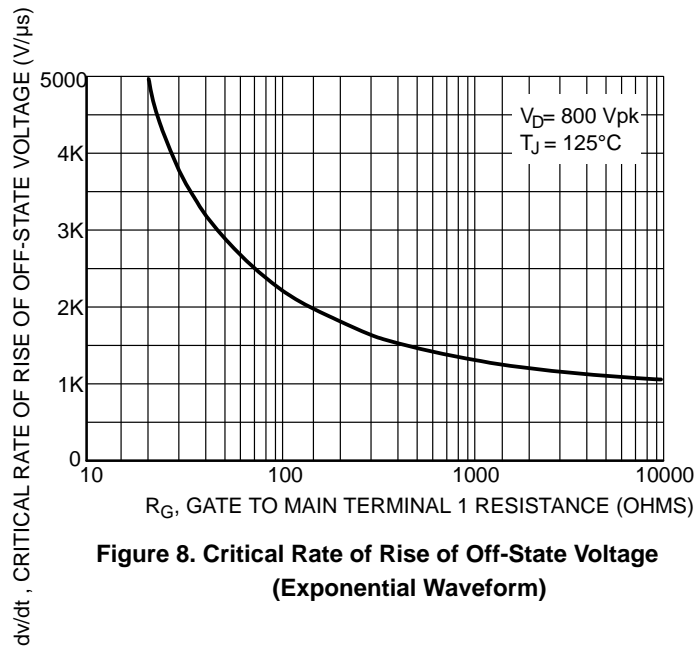
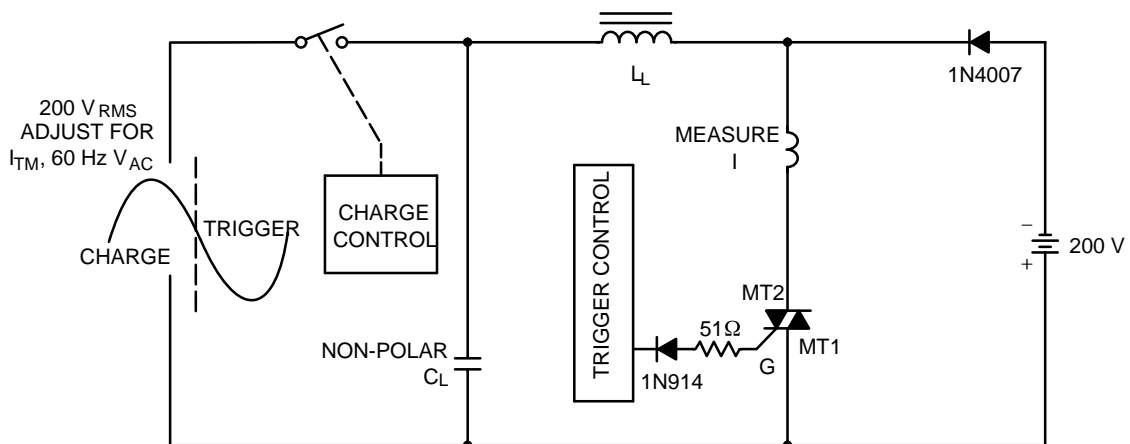

Figure 8. Critical Rate of Rise of Off-State Voltage (Exponential Waveform)



Note: Component values are for verification of rated $(di/dt)_c$. See AN1048 for additional information.

Figure 9. Simplified Test Circuit to Measure the Critical Rate of Rise of Commutating Current $(di/dt)_c$