

ZENER DIODE SILICON DIFFUSED JUNCTION TYPE

Features

- High surge power withstanding capabilities that absorb load dump surge.
- Low leakage current
- Low forward voltage drop
- Available in uni-directional polarity only
- RoHS compliant
- AEC-Q101 Qualified

Applications

- Suitable to protect sensitive automotive circuit against surges and against load Dump surge
- Electronic system for use in automobile
- Electronic system for industrial use
- Electronic system for commercial use
- For communication, control of measuring, instruments, etc.

DO-218

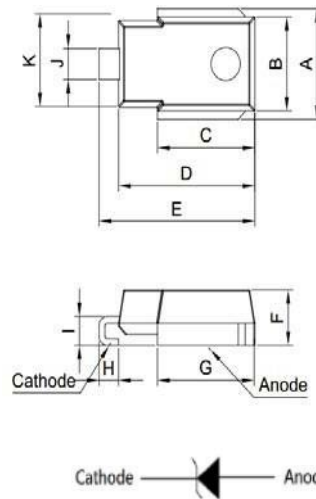

Dim.	mm
A	9.5-10.5
B	8.3-8.7
C	9.7-10.3
D	13.8-14.2
E	15.5-16.5
F	4.8-5.0
G	8.7-9.3
H	1.5-2.5
I	2.5-3.0
J	2.5-3.0
K	7.7-7.9

Package Outline Dimensions in Millimeters

MAXIMUM RATING (Ta=25°C)

PARAMETER	SYMBOL	RATING	UNIT
Allowable Power Dissipation (Note1)	P	5	W
Peak pulse power dissipation with 10/1,000us waveform	PPPM	3,600	W
Peak pulse power dissipation with 10/10,000us waveform	P _{PPM}	2,800	W
Non-Repetitive Peak Reverse Surge Current (See Fig.1 for the exponents.)	IRSM	62	A
Operating Junction Temperature	T _j	-55~175	°C
Storage Temperature Range	T _{stg}	-55~175	°C

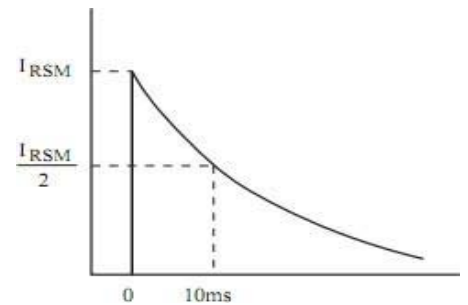

Note 1 : Lead tip temperature $T_L=25^\circ\text{C}$

CHARACTERISTIC	SYMBOL	TEST CONDITION	MIN.	TYP.	MAX.	UNIT
Breakdown Voltage	V_Z	$I_Z=10\text{mA}$	37	39	41	V
Operating Resistance	r_d	$I_Z=10\text{mA}$	-	-	30	Ω
Temperature Coefficient	α_T	$I_Z=10\text{mA}$	-	31	49	$\text{mV}/^\circ\text{C}$
Forward Voltage Drop	V_F	$I_F=6\text{A}$	-	-	1.0	V
		$I_F=100\text{A}$	-	-	1.2	V
Reverse Leakage Current	I_R	$V_R=32\text{V}$	-	-	10	μA
Clamping Voltage	V_C	$I_{RSM}=55\text{A}$	-	-	50	V

RATINGS AND CHARACTERISTICS CURVES ($T_A = 25\text{ }^\circ\text{C}$ unless otherwise noted)

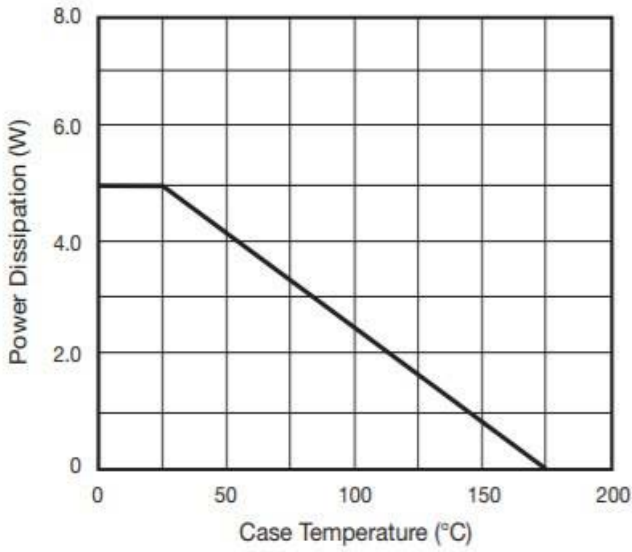

Fig. 1 - Power Derating Curve

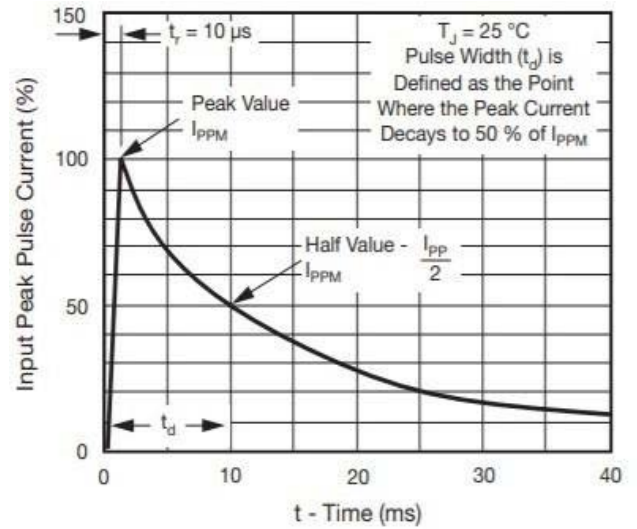

Fig. 3 - Pulse Waveform

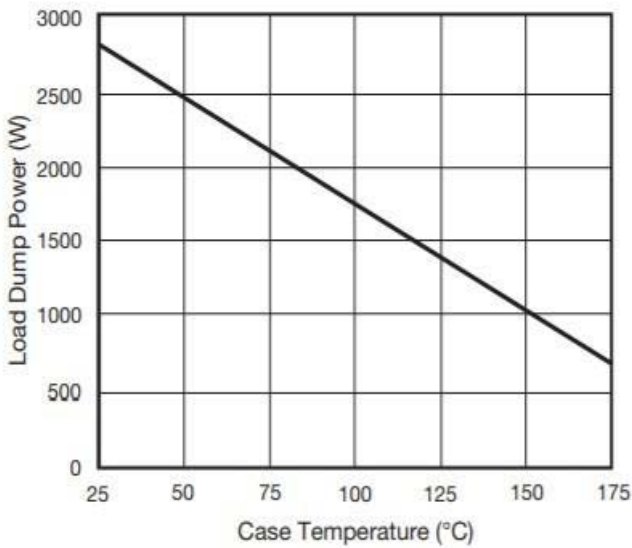

Fig. 2 - Load Dump Power Characteristics (10 ms Exponential Waveform)

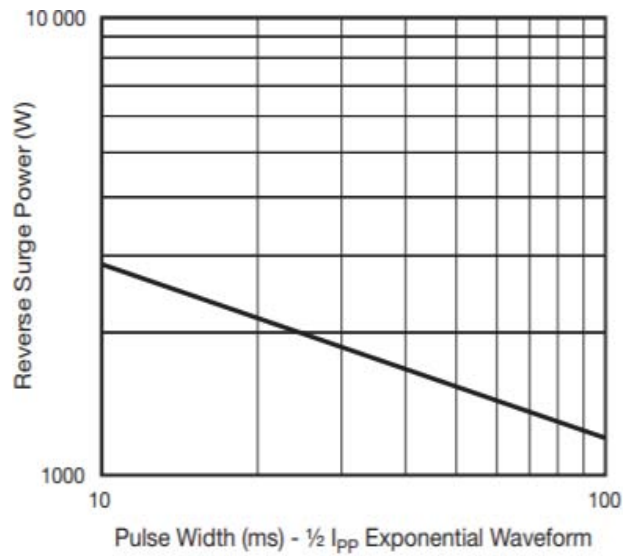

Fig. 4 - Reverse Power Capability

$P - T_L, T_a$

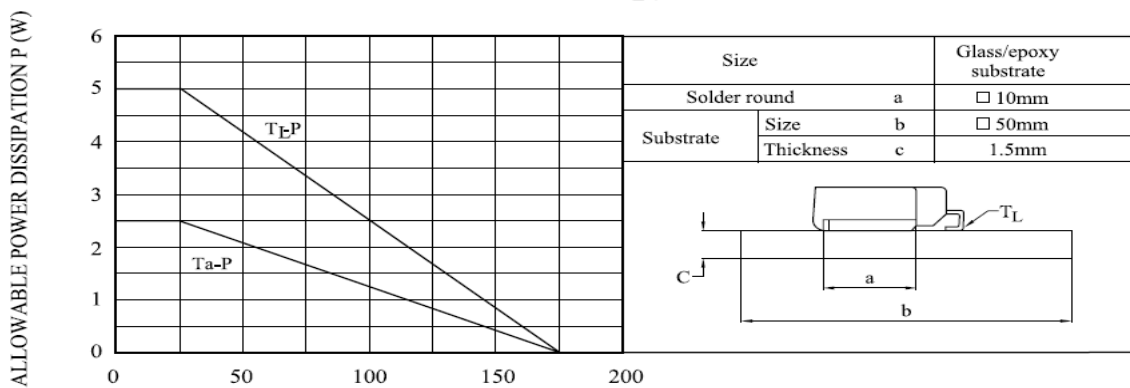
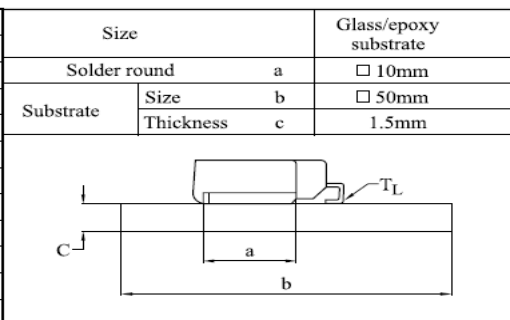

Fig. 5- LEAD TEMPERATURE T_L , AMBIENT TEMPERATURE T_a (°C)



RATINGS AND CHARACTERISTICS CURVES(Con.)

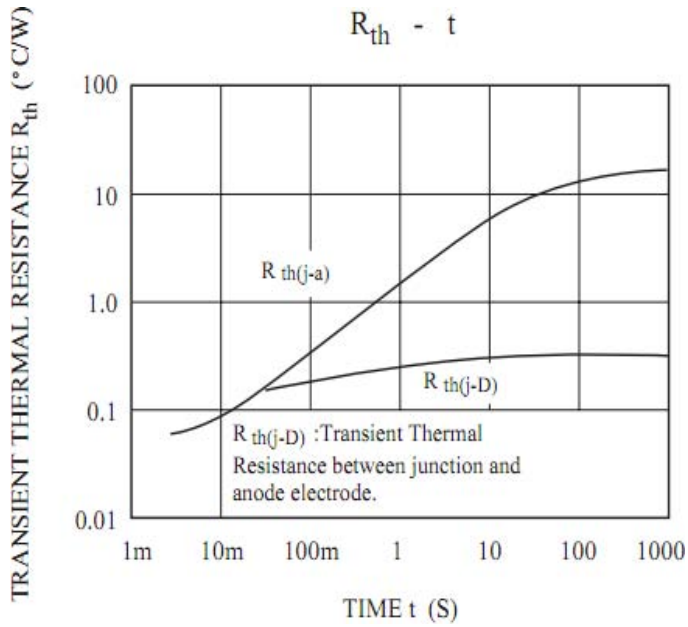

Fig.6 –Typical Transient Impedance

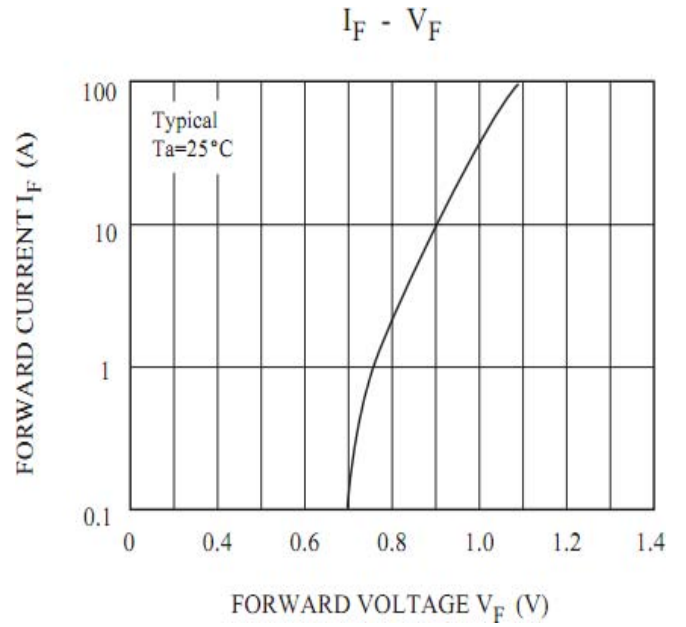

Fig.7- Typical Forward Current