

Bridge Rectifier

■ Features

- I_o 2.0A
- V_{RRM} 50V~1000V
- Glass passivated chip

■ Applications

- General purpose 1 phase Bridge rectifier applications

■ Outline Dimensions and Mark

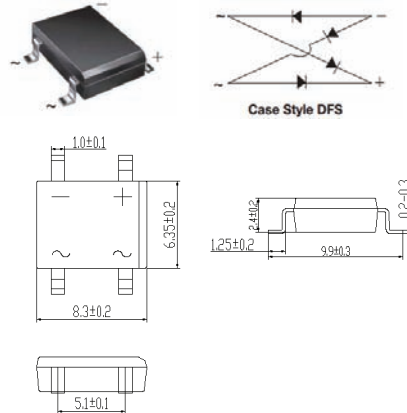

■ Limiting Values (Absolute Maximum Rating)

Item	Symbol	Unit	Conditions	DF2						
				005S	01S	02S	04S	06S	08S	10S
Repetitive Peak Reverse Voltage	V_{RRM}	V		50	100	200	400	600	800	1000
Average Rectified Output Current	I_o	A	$T_a=25^{\circ}\text{C}$ 60Hz sine wave, R-load, $T_a=25^{\circ}\text{C}$ On glass-epoxi substrate	2.0						
Surge(Non-repetitive)Forward Current	I_{FSM}	A	60Hz sine wave, 1 cycle, $T_j=25^{\circ}\text{C}$	60						
Current Squared Time	I^2t	A^2S	$1\text{ms} \leq t < 8.3\text{ms}$ $T_j=25^{\circ}\text{C}$, Rating of per diode	15						
Storage Temperature	T_{stg}	$^{\circ}\text{C}$		-55 ~+150						
Junction Temperature	T_j	$^{\circ}\text{C}$		-55 ~+150						

■ Electrical Characteristics ($T_a=25^{\circ}\text{C}$ Unless otherwise specified)

Item	Symbol	Unit	Test Condition	Max
Peak Forward Voltage	V_{FM}	V	$I_{FM}=2.0\text{A}$, Pulse measurement, Rating of per diode	1.1
Peak Reverse Current	I_{RRM}	μA	$V_{RM}=V_{RRM}$, Pulse measurement, Rating of per diode	10
Thermal Resistance	$R_{\theta J-A}$	$^{\circ}\text{C}/\text{W}$	Between junction and ambient, On glass-epoxi substrate	40
	$R_{\theta J-L}$		Between junction and lead	15

Characteristics(Typical)

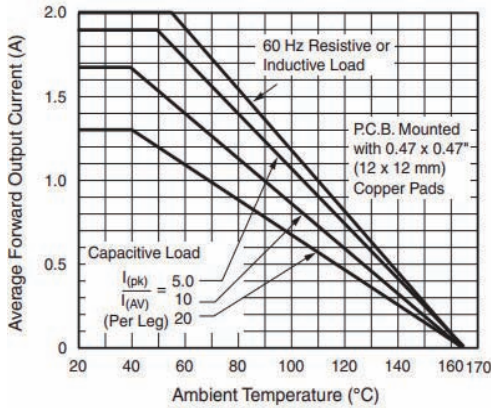

Fig. 1 - Derating Curve Output Rectified Current

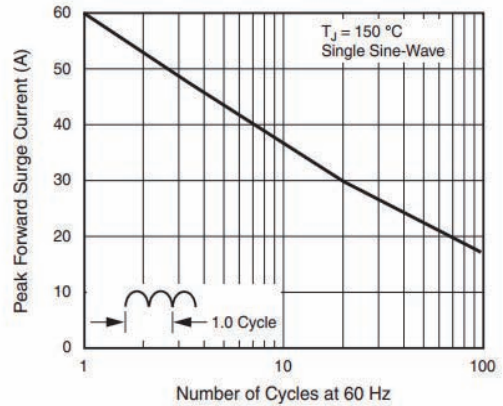

Fig. 2 - Derating Curve Output Rectified Current

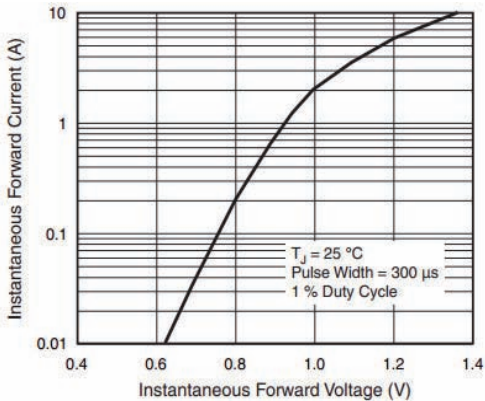

Fig. 3 - Typical Forward Characteristics Per Diode

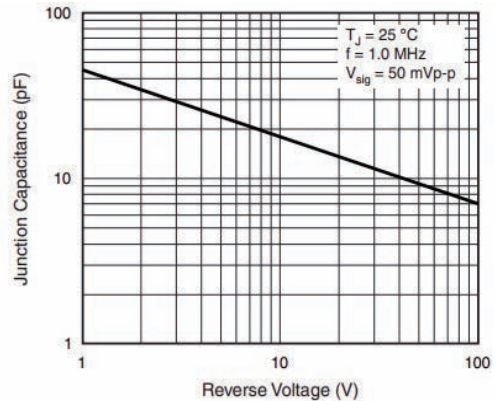

Fig. 5 - Typical Junction Capacitance Per Diode

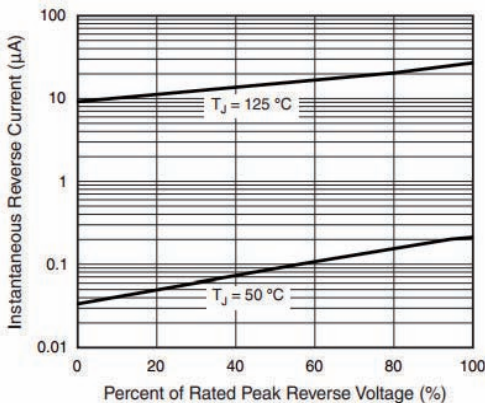

Fig. 4 - Typical Reverse Leakage Characteristics Per Diode

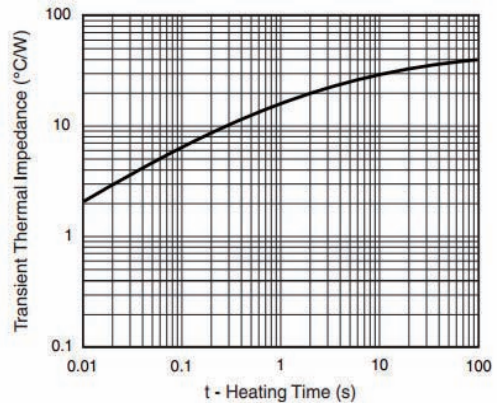

Fig. 6 - Typical Transient Thermal Impedance