

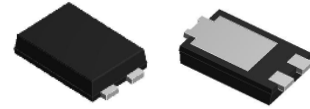

Surface Mount Schottky Rectifier
Reverse Voltage 60V , Forward Current 20A

Features

- Schottky barrier diodes
- Low forward voltage drop
- Low leakage current
- Moisture sensitivity: level 1, per J-STD-020
- Solder dip 260 °C, 10 s
- Low profile
- Heatsink design



TO-277

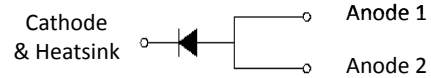

TYPICAL APPLICATIONS

For low voltage high frequency inverters, DC/DC converters and polarity protection application.

Maximum Ratings (Ta=25°C Unless otherwise specified)

Item	Symbol	Unit	Conditions	SS20U60
Repetitive Peak Reverse Voltage	VRRM	V		60
Average Rectified Output Current	I _o	A	60HZ sine wave, R- load, Ta=25°C	20
Surge(Non-repetitive)Forward Current	IFSM	A	60HZ sine wave, 1 cycle, Ta=25°C	300
Current Squared Time	i ² _t	A ² s	1ms ≤ t < 8.3ms T _j =25°C	375
Storage Temperature	T _{stg}	°C		-55 ~ +150
Junction Temperature	T _j	°C		-55~+150
Thermal Resistance(Typical)	R _{θJ-C}	°C/W	Between Junction and Case	8

Electrical Characteristics (Ta=25°C Unless otherwise specified)

Item	Symbol	Unit	Test Condition	Min	Typ	Max
Peak Forward Voltage	VFM	V	IFM =20.0A, T _j =25°C	-	0.46	0.50
			IFM =20.0A, T _j =125°C	-	0.42	0.46
Reverse Breakdown Voltage	VBR	V	IR=0.5mA	60	-	-
Leakage Current	IR	mA	VR=60V, T _j =25°C	-	-	0.3
			VR=60V, T _j =125°C	-	-	50

Rating and Characteristic Curves

FIG1: IF (AV) --Tc Derating

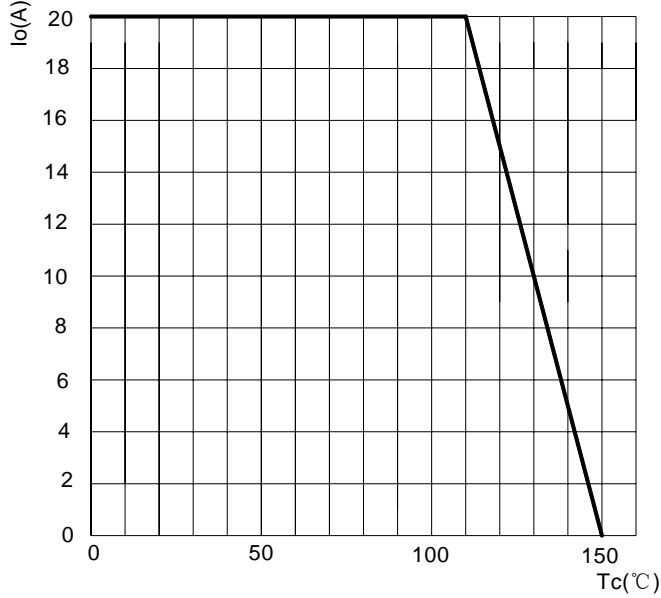

FIG2 : Surge Forward Current Capadility

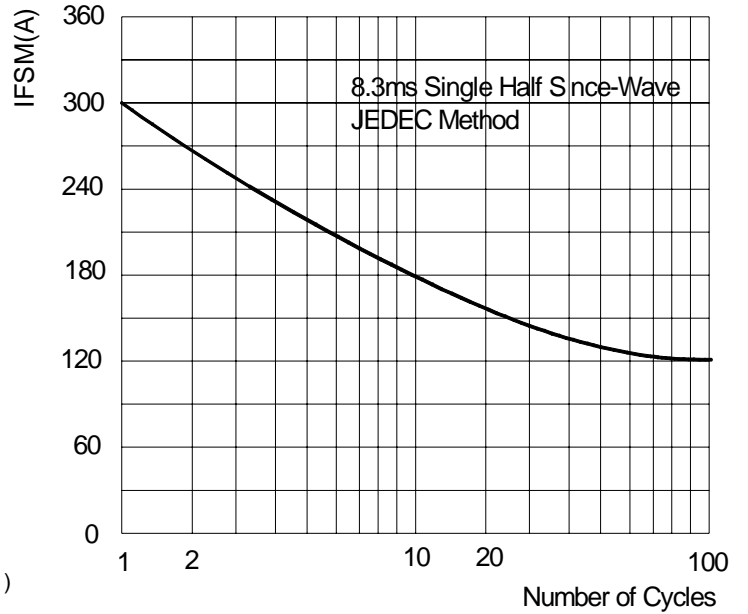

FIG3 : Instantaneous Forward Voltage

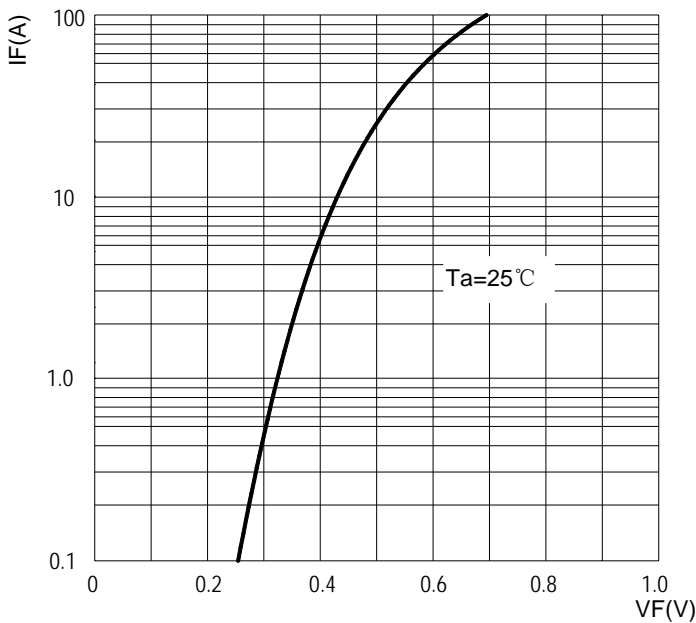
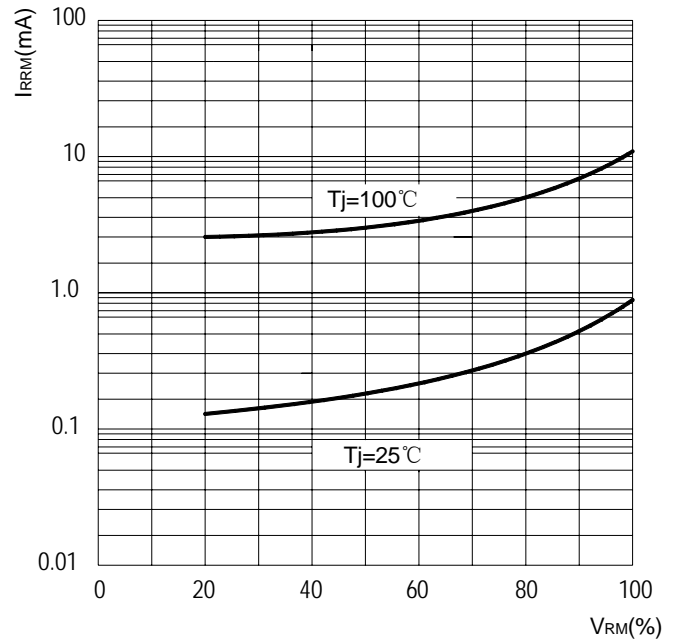
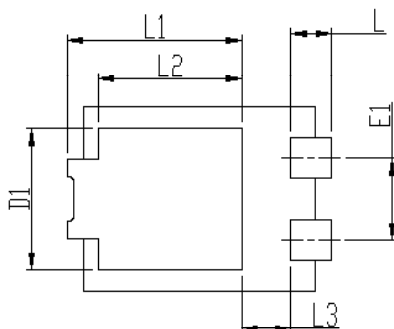
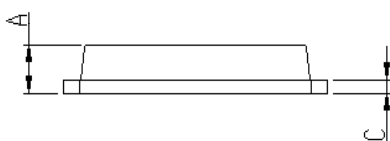
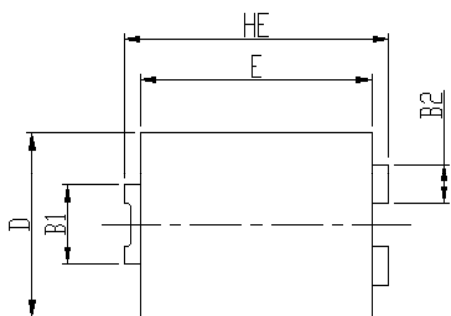

FIG4 : Typical Reverse Characteristics



PACKAGE OUTLINE DIMENSIONS



DIM	Unit: mm		Unit: inch	
	MIN	MAX	MIN	MAX
HE	6.4	6.6	0.252	0.260
E	5.6	5.8	0.220	0.228
D	4.1	4.3	0.161	0.169
B1	1.7	1.9	0.067	0.075
B2	0.8	1	0.031	0.039
A	1.05	1.2	0.041	0.047
C	0.3	0.4	0.012	0.016
L	0.85	1.1	0.033	0.043
L1	4.2	4.4	0.165	0.173
L2	3.52 Typ.		0.139 Typ.	
L3	1.1	1.4	0.043	0.055
D1	3	3.3	0.118	0.130
E1	1.86 Typ.		0.073 Typ.	

Soldering footprint

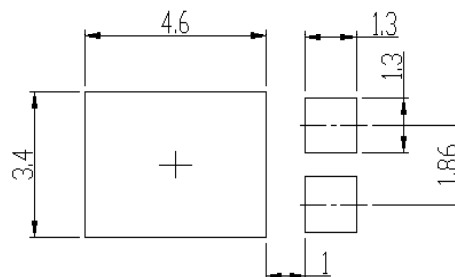

PACKING INFORMATION

Packing quantities:

5000 pcs/Reel, 12mm Tape, 13" Reel