



Dual Schottky Barrier Rectifiers
Reverse Voltage 35 to 45 Volts Forward Current 30 Ampers

Features

- ◆ Plastic package has Underwriters Laboratory Flammability Classification 94V-0
- ◆ Dual rectifier construction, positive center tap
- ◆ Metal silicon junction, majority carrier conduction
- ◆ Low power loss, high efficiency
- ◆ Guardring for overvoltage protection
- ◆ For use in low voltage, high frequency inverters, free wheeling, and polarity protection applications
- ◆ High temperature soldering guaranteed:
250°C/10 seconds, 0.25" (6.35mm) from case
- ◆ Rated for reverse surge and ESD

Mechanical Data

- ◆ Case: JEDEC TO-220AB, TO-220F, TO-263AB molded plastic body
- ◆ Terminals: Plated leads, solderable per MIL-STD-750, Method 2026
- ◆ Polarity: As marked
- ◆ Mounting Position: Any
- ◆ Mounting Torque: 10 in-lbs maximum
- ◆ Weight: 0.08 ounce, 2.24 grams

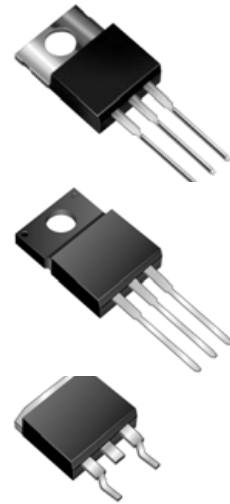

TO-220AB

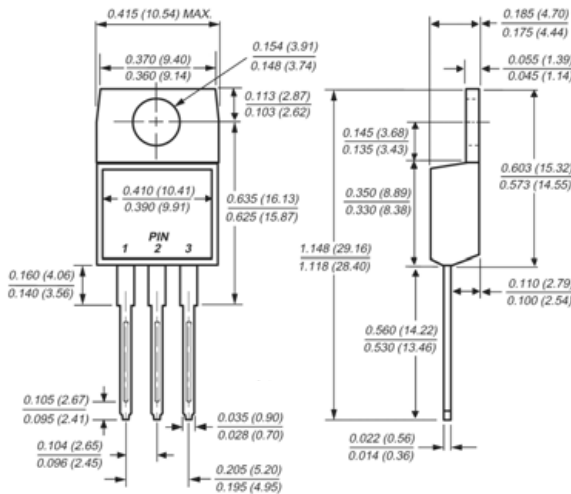

TO-220F

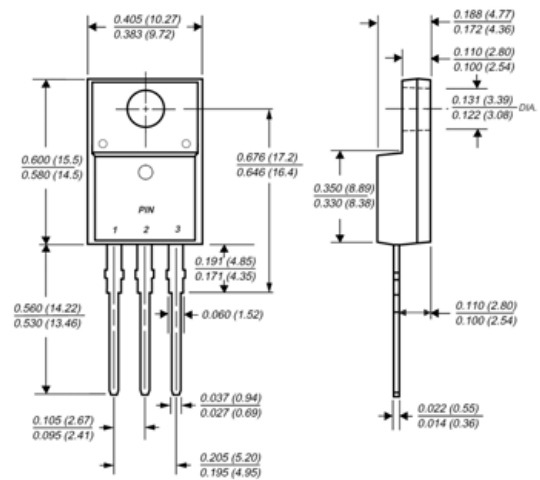

TO-263AB(D²PAK)

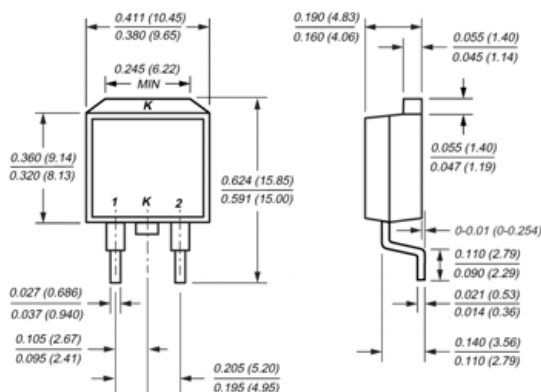

Mounting Pad Layout TO-263AB

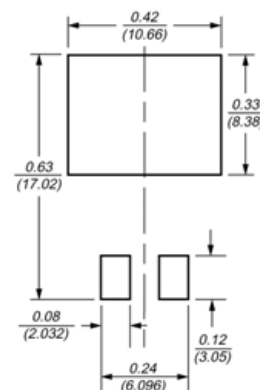

Dimensions in inches and (millimeters)



Maximum Ratings and Electrical Characteristics

($T_c = 25^\circ\text{C}$ unless otherwise noted)

Parameter	Symbol	MBR3035CT	MBR3045CT	Unit
Maximum repetitive peak reverse voltage	V_{RRM}	35	45	Volts
Working peak reverse voltage	V_{RWM}	35	45	Volts
Maximum DC blocking voltage	V_{DC}	35	45	Volts
Maximum average forward rectified current (See Fig. 1)	Total device Per leg $I_{F(AV)}$	30 15		Amps
Peak repetitive forward current (rated V_R , sq. wave, 20KHz) at $T_c=105^\circ\text{C}$	I_{FRM}	30		Amps
Peak forward surge current 8.3ms single half sine-wave superimposed on rated load (JEDEC Method) per leg	I_{FSM}	200		Amps
Peak repetitive reverse surge current per leg at $t_p = 2.0\mu\text{s}$, 1KHz	I_{RRM}	2.0		Amps
Voltage rate of change (rated V_R)	dv/dt	10,000		V/ μs
Maximum instantaneous forward voltage per leg (Note 4) at $I_F=15\text{A}$, $T_c=25^\circ\text{C}$ at $I_F=30\text{A}$, $T_c=25^\circ\text{C}$ at $I_F=30\text{A}$, $T_c=125^\circ\text{C}$	V_F	0.60 (typ) 0.76 (typ) 0.72 (typ)	0.70 (max)	Volt
Maximum instantaneous reverse current at rated DC blocking voltage per leg (Note 4) $T_J=25^\circ\text{C}$ $T_J=125^\circ\text{C}$	I_R	0.2 60		mA
Typical thermal resistance per leg	$R_{\theta JC}$	MBR 1.5 / MBRF 4.5 / MBRB 1.5		$^\circ\text{C}/\text{W}$
RMS Isolation voltage (MBRF type only) from terminals to heatsink with $t = 1.0$ second, $\text{RH} \leq 30\%$	V_{ISOL}	4500 (Note 1) 3500 (Note 2) 1500 (Note 3)		Volts
Operating junction temperature range	T_J	-55 to +150		$^\circ\text{C}$
Storage temperature range	T_{STG}	-55 to +150		$^\circ\text{C}$

- Notes:**
1. Clip mounting (on case), where lead does not overlap heatsink with 0.110" offset
 2. Clip mounting (on case), where leads do overlap heatsink
 3. Screw mounting with 4-40 screw, where washer diameter is < 4.9 mm (0.19")
 4. Pulse test: 300us pulse width, 1% duty cycle



RATINGS AND CHARACTERISTIC CURVES

($T_A = 25^\circ\text{C}$ unless otherwise noted)

Fig. 1 – Forward Current Derating Curve

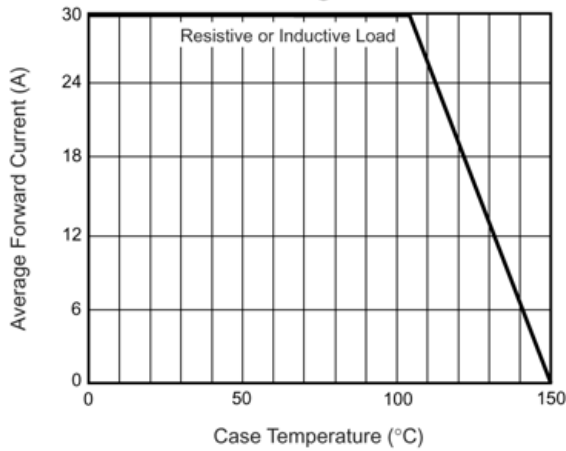

Fig. 2 – Maximum Non-Repetitive Peak Forward Surge Current Per Leg

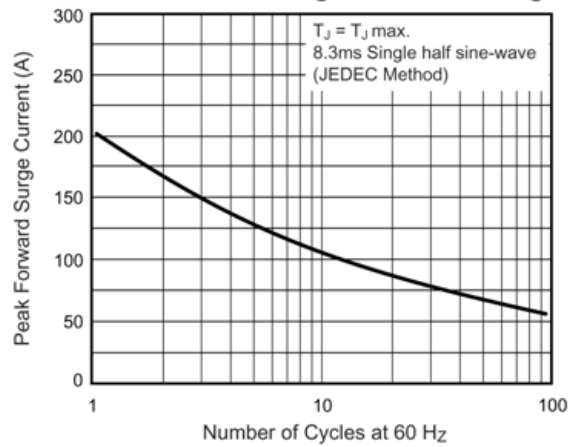

Fig. 3 – Typical Instantaneous Forward Characteristics Per Leg

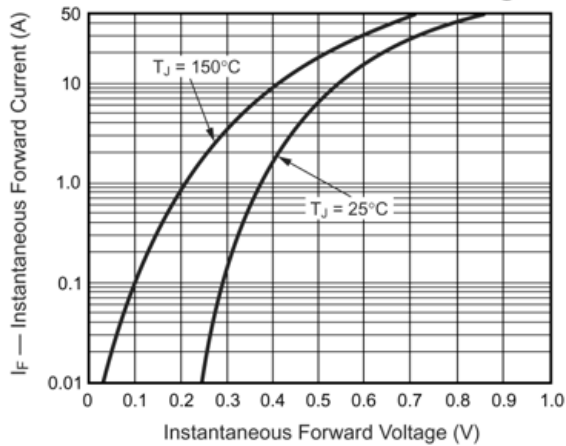

Fig. 4 – Typical Reverse Characteristics Per Leg

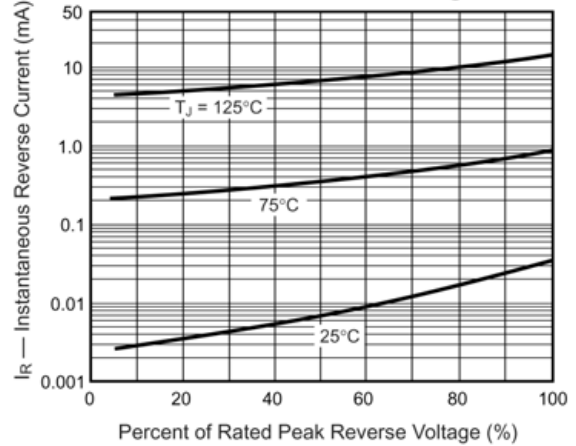

Fig. 5 – Typical Junction Capacitance Per Leg

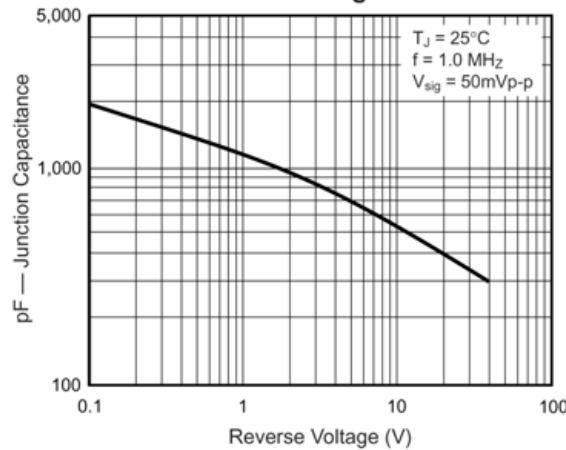

Fig. 6 – Typical Transient Thermal Impedance Per Leg

